

ELECTRICAL WIRING DIAGRAM

**NEXIA
CIELO
RACER II**

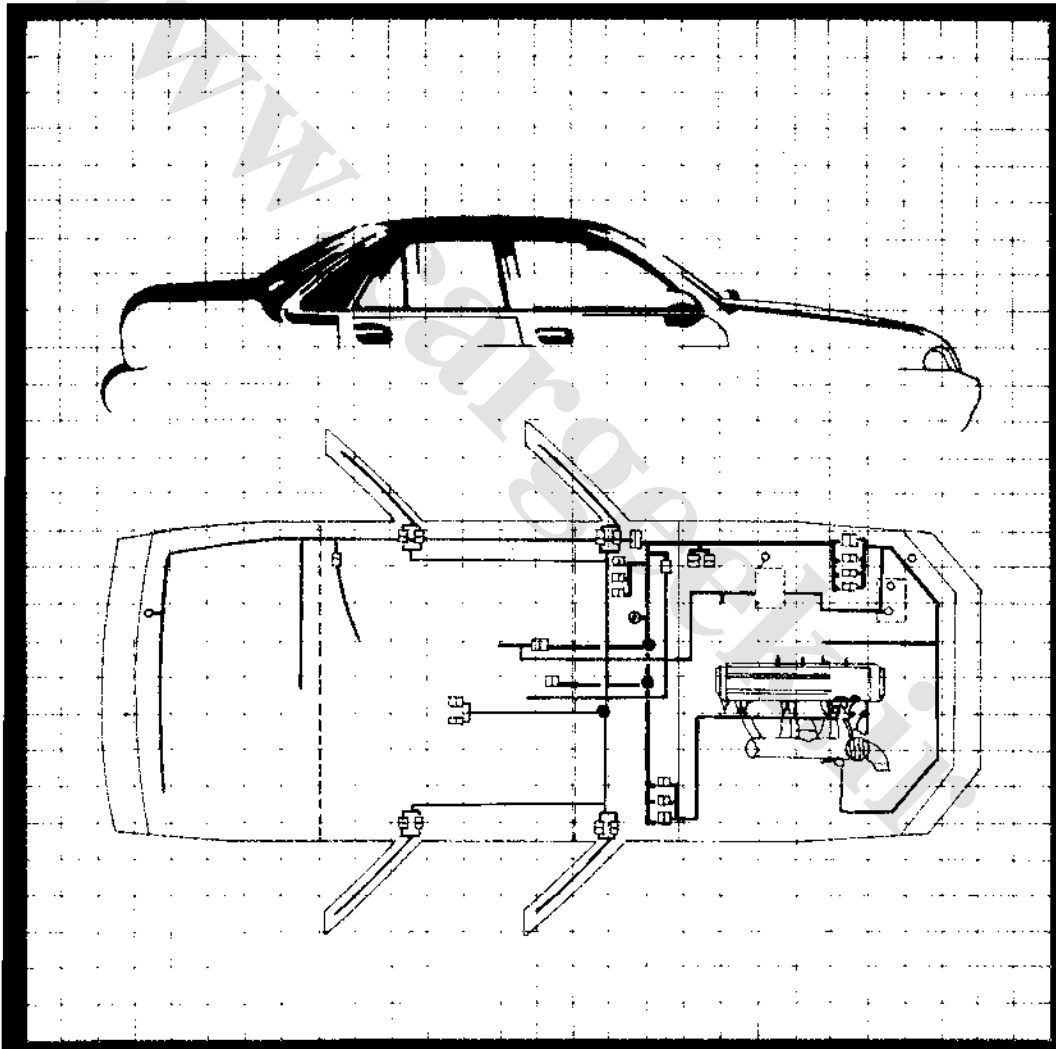

DAEWOO MOTOR CO., LTD.

ELECTRICAL WIRING DIAGRAM

NEXIA ■
CIELO ■
RACER II ■



DAEWOO MOTOR CO., LTD

CONTENTS

A. GENERAL DESCRIPTION

1. How to read wiring diagram
2. Circuit identification code
3. Wiring color
4. ECM classification

B. HARNESS CONNECTORS AND FUSE, RELAYS

1. Harness connector and ground location
2. Fuse and relay location

C. ELECTRICAL WIRING DIAGRAMS

FOREWORD

All information illustrations and specifications contained in this manual are based on the latest product information available at the time of manual approval.

The right is reserved to make changes at any time without notice.



DAEWOO MOTOR CO., LTD.

INCHON, KOREA

A. GENERAL DESCRIPTION

1. HOW TO READ WIRING DIAGRAM

Ex) E1: Head Lamp(Left)
E2: Head Lamp(Right)
K7: Head Lamp Relay

"30" Line: Battery Positive(+) Line

"15" Line: Ignition ON

"15A" Line: Ignition ON

(But, when cranking engine(Ignition III position), power is not supplied.)

"58" Line: Light Switch ON

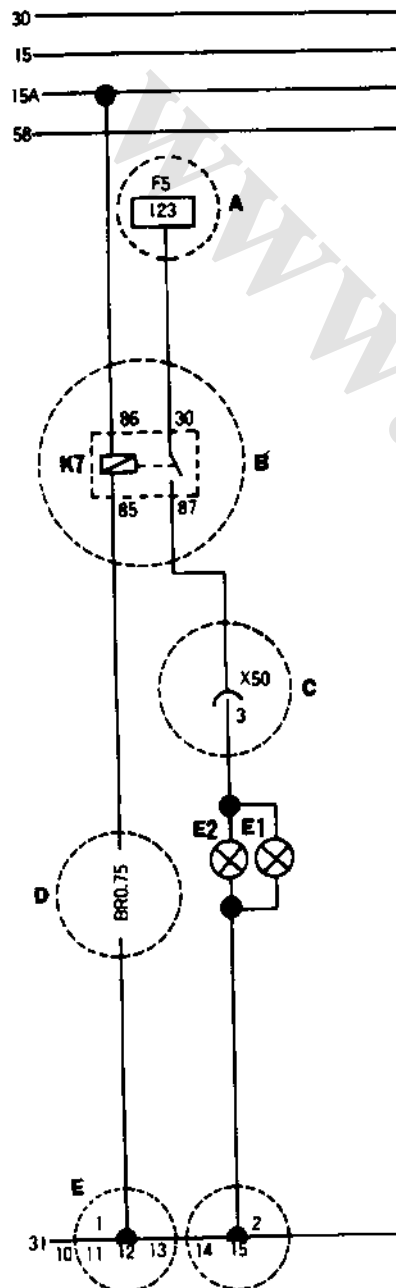

A. 123: A number(123) indicates the location of connecting wiring in this diagram.
F5: Component connected with this wiring

B. Components and Terminal Number.
K7: Head lamp Relay
86, 30, 85, 87: Terminal Number

C. Connector No. and Terminal No. of the two connecting harness.
- Terminal of X 50 Connector

D. Cable Color and Wiring Sectional Area
First Letter: Basic Color
Second Letter: Identification Color
Figure: Cross Sectional Area

E. Ground Location

"B \xrightarrow{A} ": A and B lines are connected.

"B \xrightarrow{A} ": A and B lines are not connected, but different lines.

2. CIRCUIT IDENTIFICATION CODE

IDENTIFICATION	COMPONENT	PART NAME(EXAMPLE)
E	Lamp	Head Lamp, Fog Lamp
F	Protector	Fuse
G	Power Supply	Alternator, Battery
H	Transfer	Horn, Speaker, Turn Signal Lamp
K	Relay	Relay
L	Sensor	Ignition Coil
M	Motor	Wiper Motor, Window Motor
D	Meter	Tachometer, Volt Meter
R	Resistor	Blower Resistor
S	Switch	Wiper Switch: Defroster Switch
X	Connector	Connectors Between Harnesses
Y	Electrical	Driving Unit Solenoid Valve

3. WIRING COLOR

As the wiring harness includes a large number of cables to complete individual circuits, the insulator of each cable is color coded to prevent wrong wiring. The alphabetical symbols in the following table represent the color of cables and the same symbols are also used the wiring. The cable identification symbol consists of a figure and letters.

Symbol	Color	Symbol	Color
L	blue	Br	brown
Y	yellow	Gr	grey
G	green	R	red
W	white	B	black
VIO	violet		

The figure indicates the size of wire and the first and second letters denote the basic color and identification color, respectively.

The size of wire is indicated in terms of sectional area.

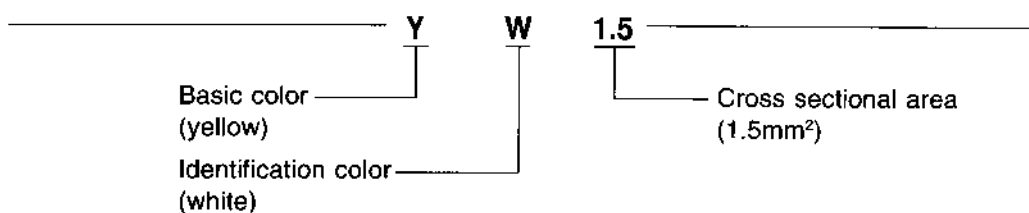

3. ECM CLASSIFICATION

○ ECM Part Number

ENGINE	EMIS- SION	T/M	E C M			LOOP	IMMO.	AREA		
			TYPE	PART/NO.	I. D					
1.5 TBI	Leaded	M/T	EFI-4	16198389	ER	OPEN		Intense cold area		
				16186399	EN			High altitude area		
				16191059	EQ			General area		
		A/T	EFI-4	16191419	ED	OPEN		High altitude area		
				16186389	EB			Hong kong, Singapore		
				16194919	RC			Chile		
	Unleaded	M/T	IEFI-S	16199339	UD	CLOSE		Guatemala		
				16201659	TF			General area		
		A/T	IEFI-S	16186529	EC			General area		
1.5 MPI	Leaded	M/T	IEFI-6	16209699	SX	OPEN		High altitude area		
				16209689	SW			Intense heat/cold area		
				16207709	ES			General area		
				16211909	PQ			High altitude area		
		A/T	IEFI-S	16211899	PR	CLOSE		Intense cold area		
				16207719	ET			General area		
				16214669	PJ			Intense heat/cold area		
				16211879	PT			Chile		
	Unleaded	M/T	IEFI-S	16217289	SC	CLOSE		Guatemala		
				16221479	FC			General area, Australia		
				16236659	CK			ISRAEL		
				16207729	EU			OPEN	NON IMMO.	
			IEFI-6	16212869	SS	CLOSE	○	Western Europe IMMO.		
				16214689	RL			Western Europe non IMMO.		
		A/T	IEFI-S	16211889	PU	CLOSE		Chile		
				16205729	EL			General area, Australia		
				16236669	CL			ISRAEL		
			IEFI-6	16214659	NA	CLOSE	○	Europe IMMO.		
				16207739	EV			General area, Western Europe		
				16236679	CM			Non immo., Australia		
1.5 DOHC	Leaded	M/T	IEFI-6	16219829	GQ	CLOSE		Intense heat/cold area		
		A/T	IEFI-6	16219329	NK	CLOSE		Intense heat/cold area		
	Unleaded	M/T	IEFI-6	16217229	HD	CLOSE		○	Europe IMMO.(Only France)	
				16219819	GP			High altitude area		
				16217239	HE			General area, Chile, Australia,		
				16235989	SE			Europe non immo.		
				16217249	HG			CLOSE	○	ISRAEL
				16214589	PF					Europe IMMO.
		A/T	IEFI-6	16214639	NB	CLOSE		○	Gneral area, Chile, Israel, Australia	
				16207779	EX				Europe IMMO.	
				16235999	SF				General area, Chile, Australia,	
									Europe non immo.	
							ISRAEL			

o ECM Identification Method

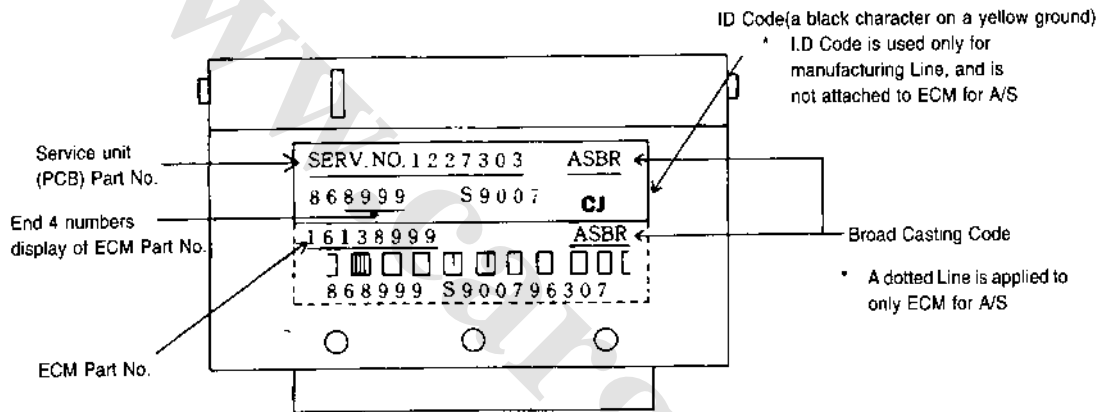

You can not exchange IEFI-S ECM, and IEFI-6 ECM each other because those are different.

B. HARNESS CONNECTORS AND FUSE, RELAYS

1. HARNESS CONNECTORS AND GROUND LOCATION

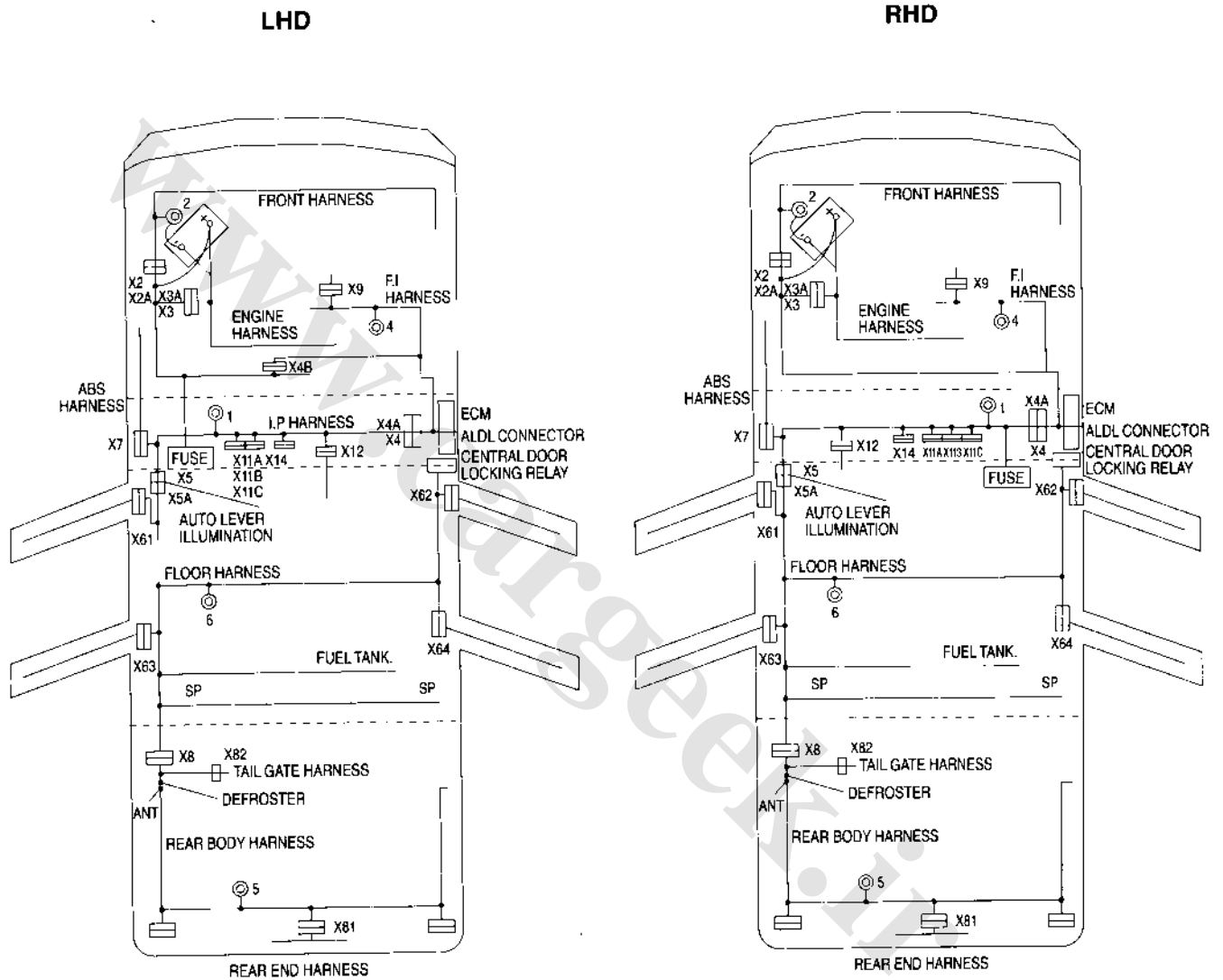

1-1. CONNECTOR DESCRIPTION

X2	Connector for IP and Front Harness(14 pin)
X2A	Connector for IP and Front Harness(8 pin)
X3	Connector for IP and Engine Harness(14 pin)
X3A	Connector for IP and Engine Harness(4 pin)
X4	Connector for IP and FI Harness(14 pin)
X4A	Connector for IP and FI Harness(8 pin)
X4B	Connector for IP and FI Harness(2 pin)
X41	Connector for FI and TCM Extension Harness(20 pin)
X42	Connector for FI and TCM Extension Harness(14 pin)
X43	Connector for FI and TCM Body Harness(20 pin)
X5	Connector for IP and Floor Harness(20 pin)
X5A	Connector for IP and Floor Harness(10 pin)
X61	Connector for Floor and Front-Left Door Harness(14 pin)
X62	Connector for Floor and Front-Right Door Harness(14 pin)
X63	Connector for Floor and Rear-Left Door Harness(7 pin)
X64	Connector for Floor and Rear-Right Door Harness(7 pin)
X7	Connector for IP and ABS Harness(6 pin)
X8	Connector for Floor and Rear Body Harness(14 pin)
X81	Connector for Rear Body and Rear-End Harness(2 pin)
X82	Connector for Rear Body and Tail Gate Harness(2 pin) - 3 Door, 5 Door Vehicle
X9	Connector for FI and DOHC Injector Harness(2 pin) - DOHC Vehicle
X11A	Connector for IP Harness and Instrument Panel(16 pin)
X11B	Connector for IP Harness and Instrument Panel(12 pin)
X11C	Connector for IP Harness and Instrument Panel(6 pin) - Auto T/M 4-SP Vehicle
X12	Connector for IP Harness and Center Console Harness(5 pin)
X13	Connector for IP harness and Air Bag Harness(4 pin)
X14	Connector for IP and Car Audio(13 pin)

* Abbreviation

IP: Instrument Panel

FI: Fuel Injection

1-2. GROUND LOCATION

1: Located at the center of steering column

2: Located at the side of battery

4: Located on the head side of engine cylinder

5: Located in the trunk room

6: Located under the drivers seat

B: Body ground(part body is directly grounded to the vehicle body)

2. FUSE AND RELAY LOCATION

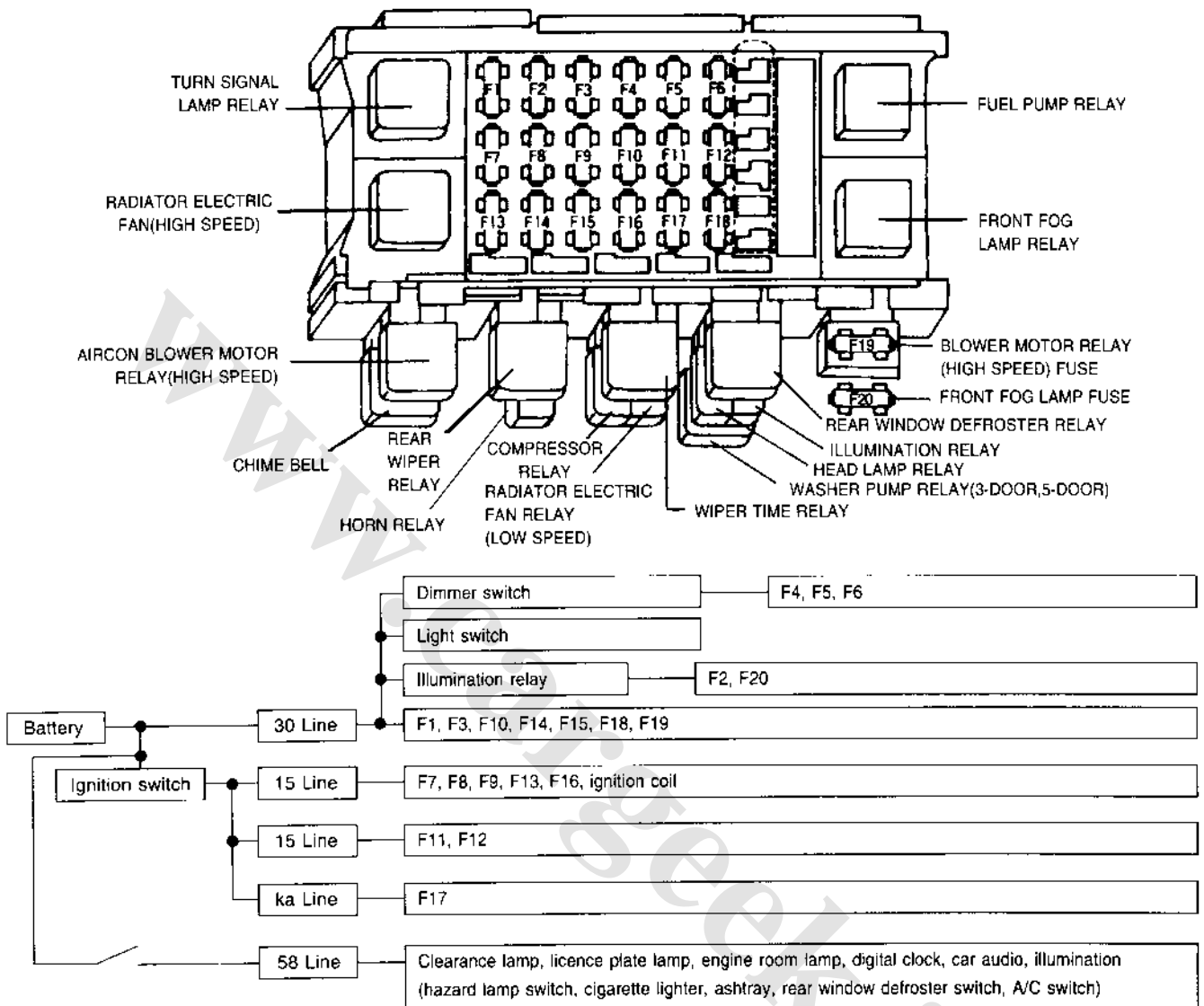

2) Fuse usage

Fuse No.	Capacity (A)	Usage	Fuse No.	Capacity (A)	Usage
1	10	ECM, TCM	12	30	Radiator temperature switch, A/C control switch
2	10	Parking lamp	13	20	Digital clock, reverse lamp, warning buzzer, rear window defroster switch, alternator "F", IP, cigarette lighter, glove box lamp
3	10	Air bag	14	30	Horn, electric fan relay
4	20	Head lamp high beam	15	20	Digital clock, hazard lamp switch, room lamp, trunk room lamp, warning buzzer, auto antenna
5	10	Head lamp low beam(left), HLLD motor(left)	16	30	Power window
6	10	Head lamp low beam(right), HLLD unit, HLLD motor(right)	17	10	Cassette
7	30	injector, TCM, Immobilizer	18	30	Auto trunk switch, rear window defroster time relay, central door locking relay, cassette
8	20	Brake s/w, fuel pump relay, hazard lamp switch, ABS	19	30	Blower motor relay
9	30	Wiper relay	20	30	Front fog
10	10	Fuel inlet solenoid switch, ABS, immobilizer			
11	10	A/C compressor relay			

C. ELECTRICAL WIRING DIAGRAMS

C-1 Harness Connector Faces

C-2 Electrical Wiring Diagram

1) Ignition Switch, Starter Motor, Alternator, Wiring	14
2) Ignition Wiring (IEFI-6)	16
3) Injection Nozzle, ECM Power, ECM Ground "Wiring(IEFI-6)	18
4) Coolant Temperature Sensor(CTS), Manifold Air Pressure(Map) Sensor,	20
Vehicle Speed Sensor, Throttle Position Sensor(TPS) IAC Valve, O2 Sensor wiring(IEFI-6)	
5) "Service Engine Soon" Light, TCC, Fuel Pump, ALDL Tester Wiring(IEFI-6)	22
6) Ignition Wiring(IEFI-S)	24
7) Injection Nozzle, ECM Power, ECM Ground Wiring(IEFI-S)	26
8) Coolant Temperature Sensor(CTS), Manifold Air Pressure(MAP) Sensor,	28
Vehicle Speed Sensor, Throttle Position Sensor(TPS) IAC Valve, O2 Sensor wiring(IEFI-S)	
9) "Service Engine Soon" Light, TCC, Fuel Pump, ALDL Tester Wiring(IEFI-S)	30
10) Light Wiring	32
11) Front Fog Lamp & Rear Fog Lamp	34
12) Day Time Running Light, Clearance Lamp, Licence Plate Lamp, Horn Wiring	36
13) Glove Box Lamp, Cigarette Lighter, Digital Clock Room Lamp,	38
Trunk Room Lamp, Wiring	
14) Brake Lamp, Reverse Lamp, TCC Wiring	40
15) Turn Signal Lamp, hazard Lamp Wiring	42
16) Warning Buzzer, Auto Trunk, Fuel Inlet Switch Wiring	44
17) Rear Window Defroster Wiring	46
18) Wiper Wiring	48
19) Cassette Radio Wiring	50
20) Power Window Wiring(LHD, RHD)	52
21) Central Door Locking System Wiring(LHD, RHD)	54
22) I-P Wiring	57
23) ABS (Option)	60
24) TCM(Option)	61
25) Immobilizer, Air Bag(Option)	62
26) Air-Conditioning Wiring, Electric Fan, Blower Motor Wiring(IEFI-6 type)	63
26-1) Air-Conditioning Wiring, Electric Fan, Blower Motor Wiring(IEFI-S type)	67
27) Head Lamp Leveling Device(Option)	69

C-1. HARNESS CONNECTOR FACES

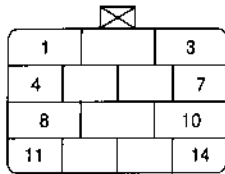

X2 CONNECTOR

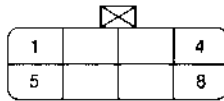

X2A CONNECTOR

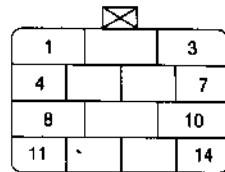

X3 CONNECTOR

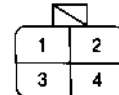

X3A CONNECTOR

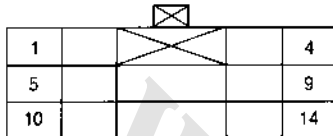

X4 CONNECTOR

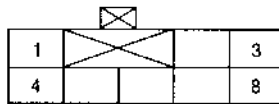

X4A CONNECTOR

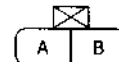

X4B CONNECTOR

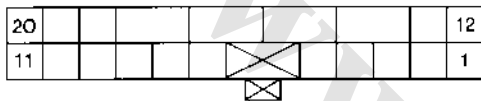

X5 CONNECTOR

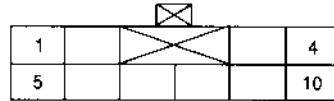

X5A CONNECTOR

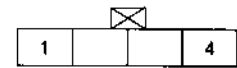

X13 CONNECTOR(AIR BAG)

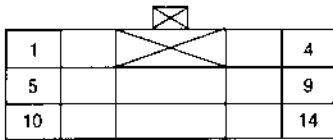

X61, X62, X8 CONNECTOR

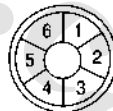

X63, X64 CONNECTOR

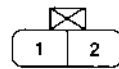

X9 CONNECTOR
(DOHC VEHICLE)

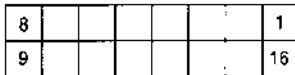

X11A

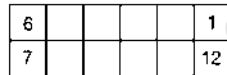

X11B



X11C

I-P CONNECTOR

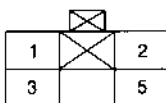

X12 CONNECTOR

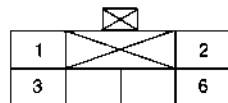

X7 CONNECTOR



X14 CONNECTOR (CASSETTE RADIO)

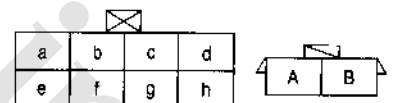

A/C SWITCH CONNECTOR

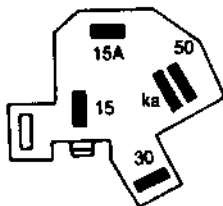

IGNITION SWITCH

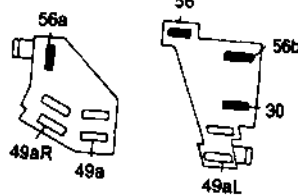

DIMMER SWITCH CONNECTOR

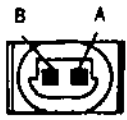

INJECTOR CONNECTOR



CTS CONNECTOR

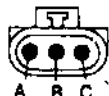

MAP SENSOR



TPS CONNECTOR



IACV CONNECTOR



O₂ SENSOR CONNECTOR

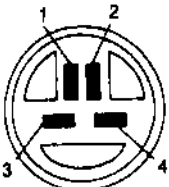

WIPER MOTOR CONNECTOR

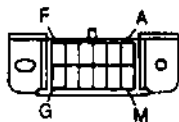

ALDL CONNECTOR

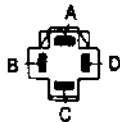

BRAKE SWITCH CONNECTOR



TCC SOLENOID VALVE CONNECTOR



FUEL PUMP CONNECTOR



FUEL PUMP RELAY CONNECTOR

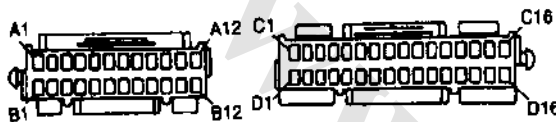

ECM CONNECTOR

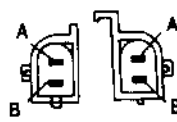

IGNITION COIL CONNECTOR

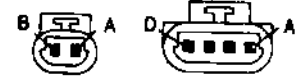

DISTRIBUTOR CONNECTOR



P/N SW CONNECTOR(3-SP A/T)

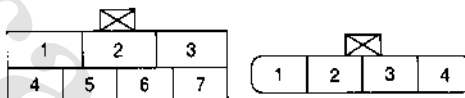

NSBU SWITCH(4-SP A/T)

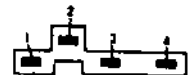

BLOWER MOTOR RESISTER



CLOCK CONNECTOR

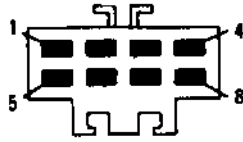

WARNING BUZZER

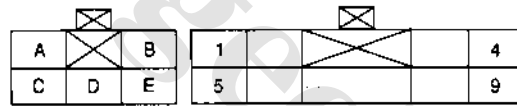

POWER WINDOW MAIN SWITCH

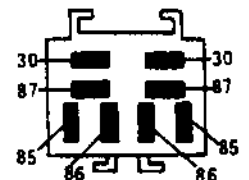

HEAD LAMP RELAY

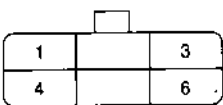

HEAD LAMP CONNECTOR

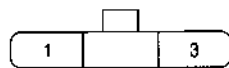

SIGNAL LAMP CONNECTOR

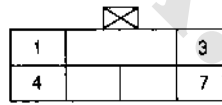

REAR COMBI LAMP CONNECTOR

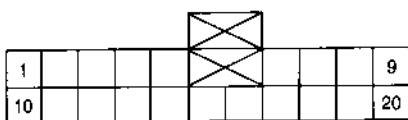

X41 CONNECTOR(4-SP A/T)

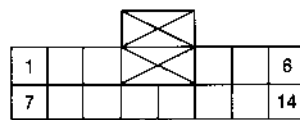

X42 CONNECTOR(4-SP A/T)

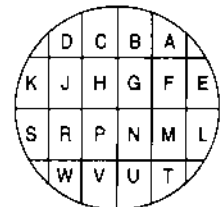

X43 CONNECTOR(4-SP A/T)

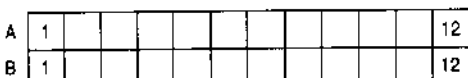

TCM CONNECTOR(4-SP A/T)

C-2. ELECTRICAL WIRING DIAGRAM

1) IGNITION SWITCH, STARTER MOTOR, ALTERNATOR WIRING

- G1 BATTERY
- M1 STARTER MOTOR
- S1 IGNITION SWITCH
- S2 P/N SWITCH
- G2 ALTERNATOR

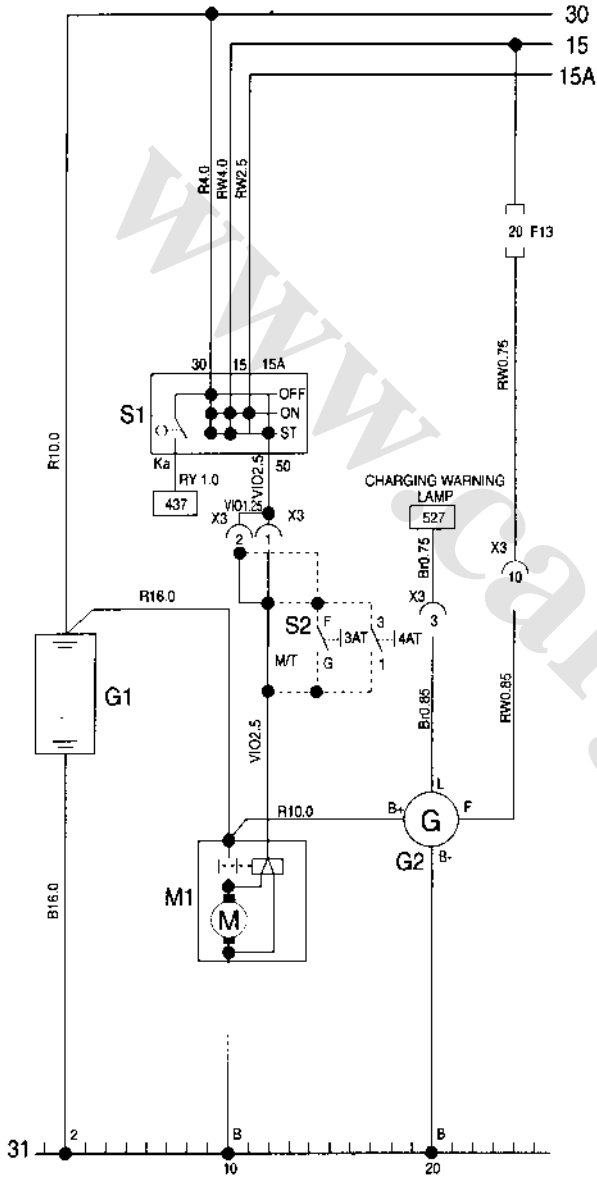

IGNITION SWITCH

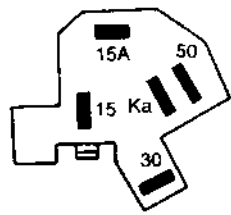

IGNITION SWITCH

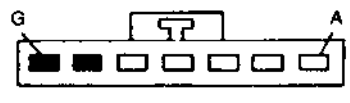

P/N SWITCH CONNECTOR

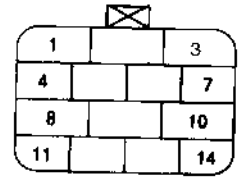

X2, X3 CONNECTOR (I.P WIRING HARNESS REFERENCE)

- S2: P/N Switch(Auto Transmission)
This is a safety circuit to start an engine only when a shift lever is the position of P or N on a vehicle. A cross point is "ON" at the P or N position.
- 527 Analog, Instrument Panel.
 - This is a line connected to a battery charging warning lamp on the instrument panel.
 - When an ignition switch is "ON" a rotor coil is magnetized through the "L" terminal of an alternator. At this time, the "L" terminal power is 1 to 3 Volt when an engine is started, the "L" terminal power is equal to the charging voltage.
 - When a terminal "L" is disconnected or cut off, the terminal "F" is an compensating circuit to magnetics a rotor coil instead of the terminal "L".
 - When an ignition switch is on, the current flows as follows: F13 → battery charging warning lamp → L terminal → rotor coil → ground and the charging warning lamp is on. But when an engine is started, the charging warning lamp is off because "L" terminal power is equal to B+ voltage.

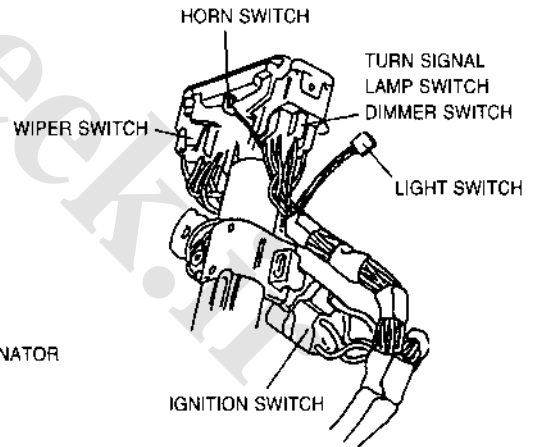
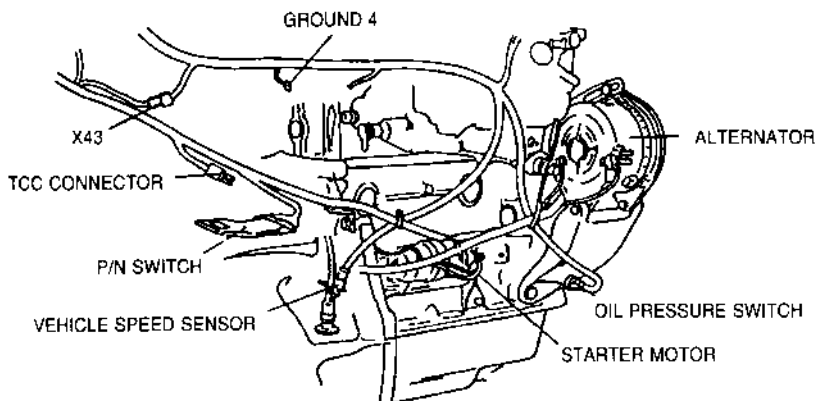
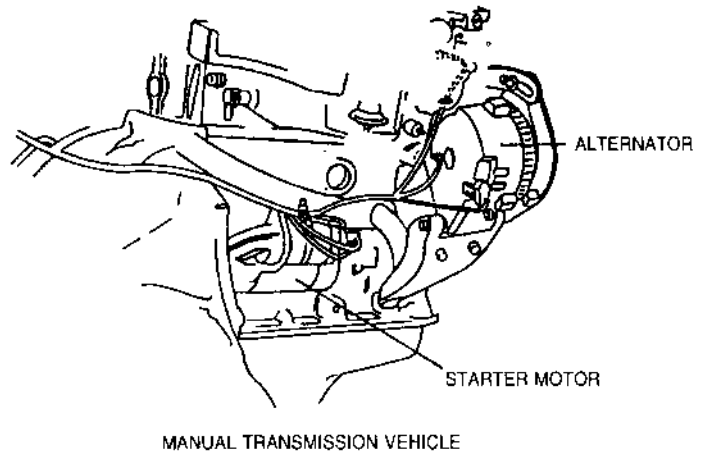
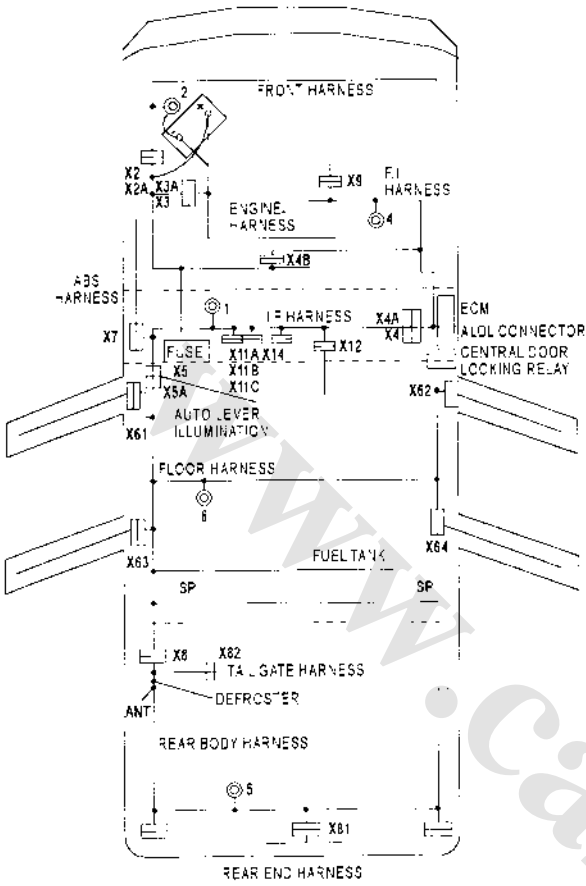

2) IGNITION WIRING(IEFI-6)

- K1 ECM
- L1 IGNITION COIL
- Y1 IGNITION MODULE
- Y2 DISTRIBUTOR

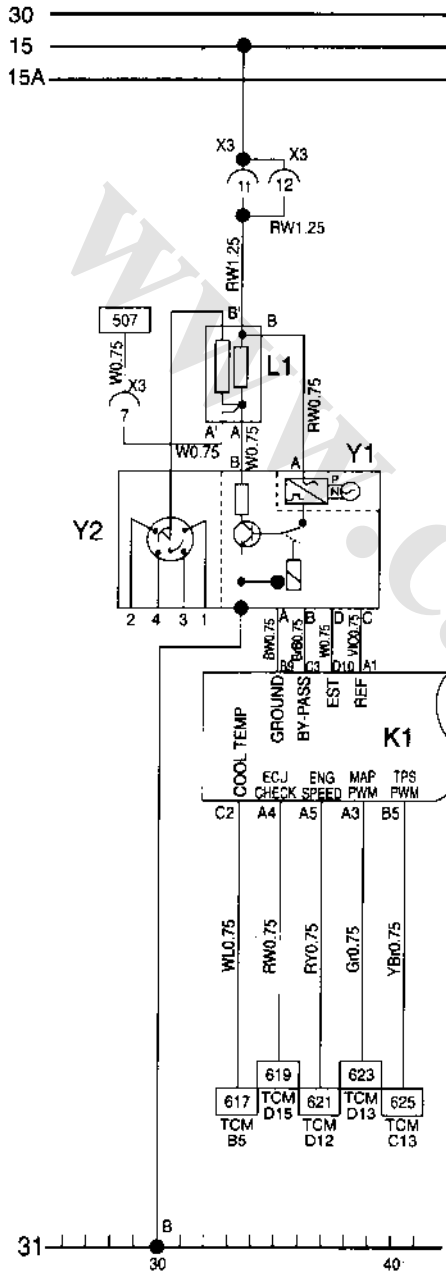

- L1 Ignition Coil
 - Insulation Resistance: ∞
 - 1st Resistance: 0.35-0.45ohms
 - 2nd Resistance: 7.5-9.5kilo-ohms
- Y1 Ignition Module
 - Pick up Coil
 - Insulation Resistance: ∞
 - Coil Resistance: 500-1500ohms
 - Ignition System Check

Measuring terminal	Cranking	Starting
Ground - Distributor A	0V	0V
Ground - Distributor B	10-20mV	4.5-5.0V
Ground - Distributor C	0.5-1.5V	0.7-2.7V
Ground - Distributor D	0.2-0.3V	1.0-3.0V

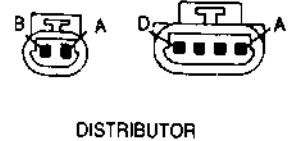
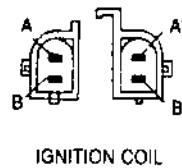
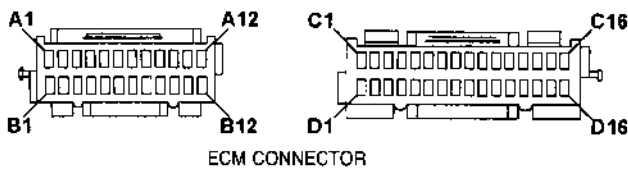

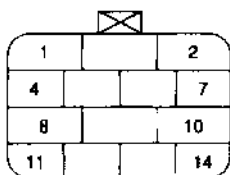
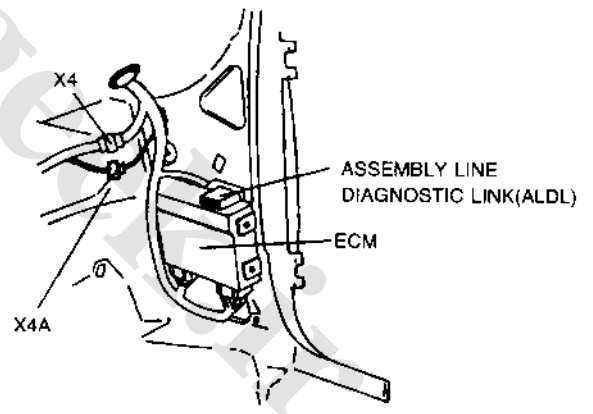
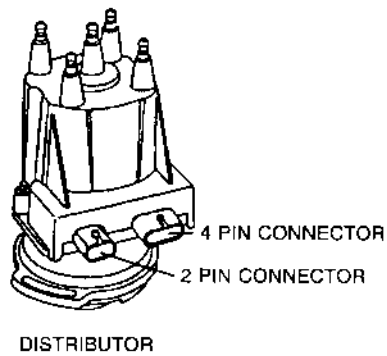
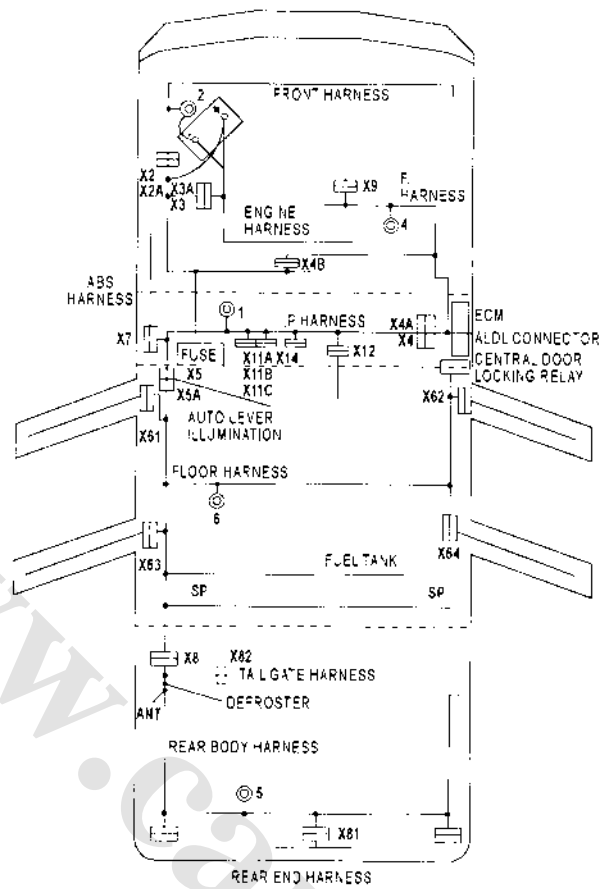

X2, X3 CONNECTOR
 (I.P WIRING HARNESS REFERENCE)

3) INJECTION NOZZLE, ECM POWER, ECM GROUND WIRING(IEFI-6)

K1 ECM
Y3 INJECTOR

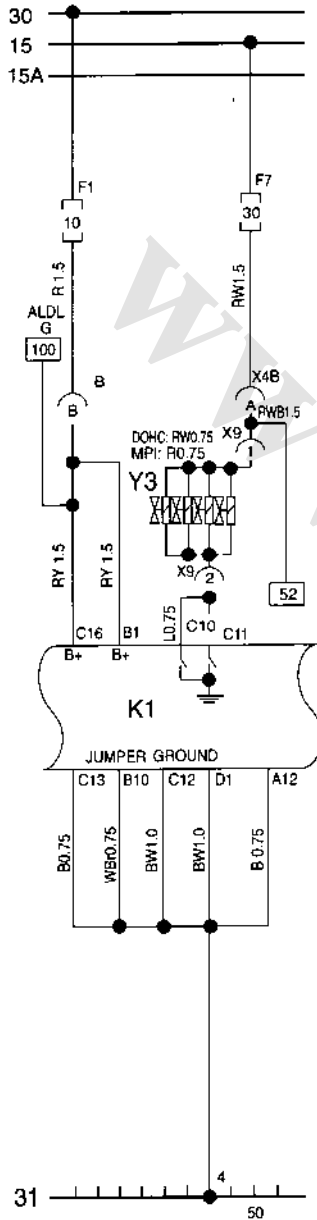

- F1 Fuse Number 1
This is a fuse which always feeds "B+" power to ECM. If you are to delete a fault code memorized on the ECM. Do as follows:
 - Set ignition Switch to "OFF" position
 - Disconnect Fuse and wait for about 10 seconds
 - Connect Fuse again
- Y3 Injection Valve(Injector)
 - Resistance Valve: 1-2ohms
 - Fuel Pressure: 0.75 bar
- K1 ECM Ground
 - ECM ground is at the terminal of ECM such as D1, C12 and B10.
 - Three ground terminals are at one location which is on the cylinder head.

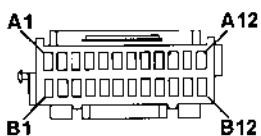

ECM CONNECTOR

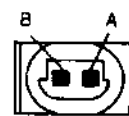
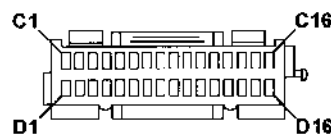

INJECTION VALVE

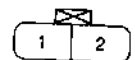

X9 CONNECTOR

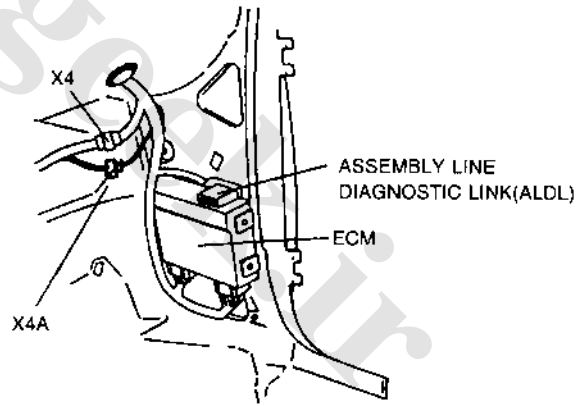
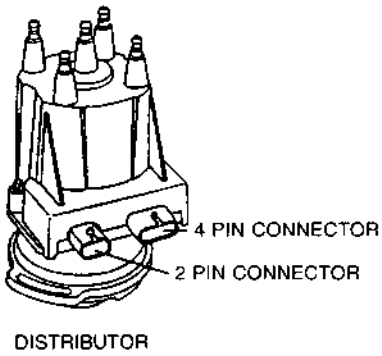
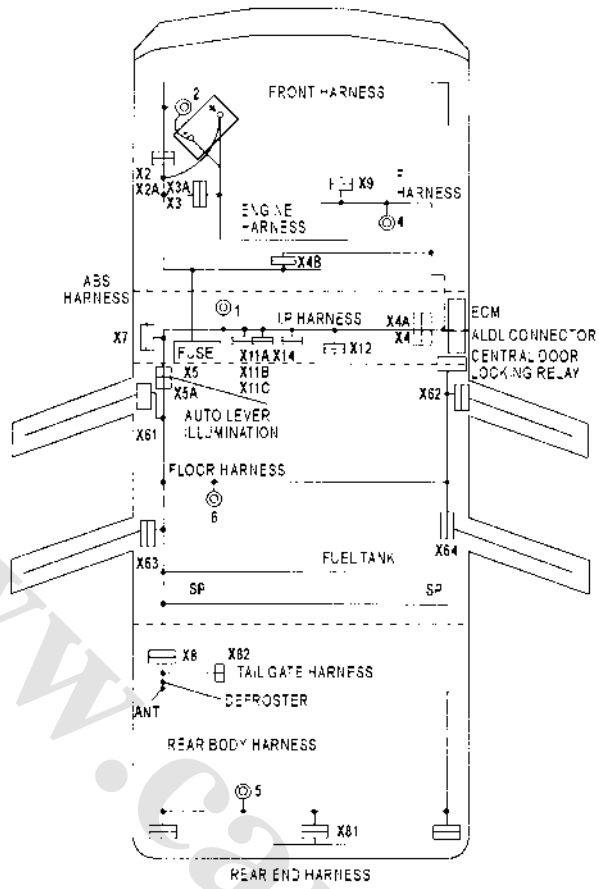

4) COOLANT TEMPERATURE SENSOR(CTS), MANIFOLD AIR PRESSURE(MAP) SENSOR, VEHICLE SPEED SENSOR, THROTTLE POSITION SENSOR(TPS) IAC VALVE, O₂ SENSOR WIRING(IEFI-6)

- K1 ECM
- M2 IDLE AIR CONTROL VALVE(IAC VALVE)
- P1 VEHICLE SPEED SENSOR(VSS)
- P2 COOLANT TEMPERATURE SENSOR(CTS)
- P3 INTAKE MANIFOLD-AIR PRESSURE SENSOR(MAP)
- X3 OCTANE SELECTOR CONNECTOR
- P4 THROTTLE POSITION SENSOR(TPS)

- P5 O₂ SENSOR (UNLEADED TYPE)
- P5-1 O₂ SENSOR (1.5 DOHC LEADED TYPE)
- P5-2 CO POTENTIO METER(1.5 MPFI LEADED TYPE)
- P6 MANIFOLD AIR TEMPERATURE SENSOR(MAT)

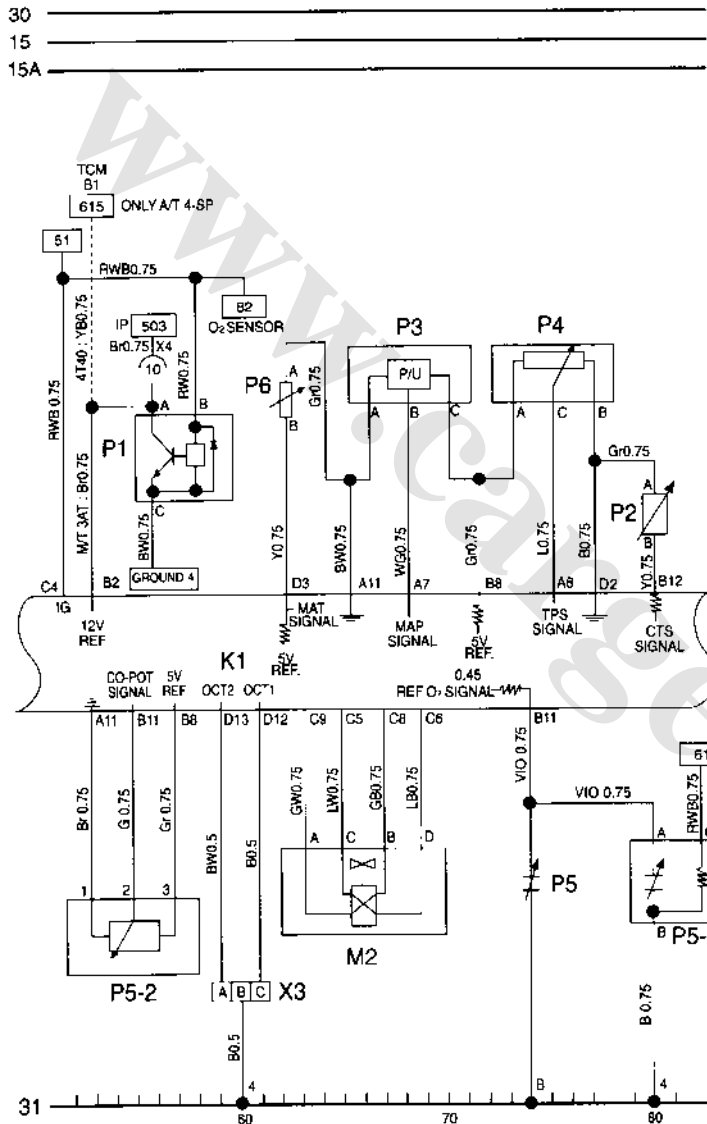

Fault Code

Stored fault code	Information sensor	Cause of fault
13	Oxygen sensor	No voltage change
14	Coolant temperature sensor	Voltage too high or low
21	Throttle position sensor	Voltage too high or low
23	Manifold air temperature sensor	Voltage too high or low
24	Vehicle speed sensor	No speed impulses
32	EGR failure	
33	Manifold absolute pressure(MAP) sensor	Voltage too high or low
42	Electrical spark advance	No electr. spark advance
44	Oxygen sensor	Air/fuel mixture too lean
45	Oxygen sensor	Air/fuel mixture too rich
51	ECM	ECM/EPROM fault
53	Immobilizer failure	
54	Co adjust error	

How to check a fault code

- If the "Service Engine Soon" indicator lights up while driving the engine, a fault has occurred to electronic control system.
- Trouble code can be obtained by flashing the "Service Engine Soon" light if jumpering ALDL terminal "B" to "A"(using ALDL key) with the ignition "ON".
- To erase the trouble code, disconnect fuse #1 for 10 seconds with ignition switch "OFF".

P2 Coolant Temperature Sensor(CTS)

Temperature(°C)	Resistance(kilo-ohms)
100	0.185
70	0.45
20	3.4
-4	7.5
-40	100

P3 Intake manifold Air Pressure Sensor(MAP)

Pressure(bar)	MAP signal voltage(v)	Remarks
-0.2	3.7±0.2	Measuring at the Ter A and Ter B of MAP
-0.4	2.5±0.2	Measuring at the Ter A and Ter B of MAP
-0.6	1.5±0.2	Measuring at the Ter A and Ter B of MAP
-0.8	0.5±0.2	Measuring at the Ter A and Ter B of MAP

P4 Throttle Position Sensor(TPS)

Throttle valve opening(%)	Resistance (kilo-ohms)	Signal Voltage(V)	Remarks
0	2±1	0.5±0.2	Measuring between the TPS Ter B and C
50	3.5±1	2.5±0.2	
100	6.5±1	4.5±0.2	

P5 O₂ Sensor

- Voltage is changed between 0.1 and 0.9V

M2 Idle Air Control Valve(IAC Valve)

- Idle RPM speed: 800-850 RPM

Resistance(ohms)	Remarks
20-100	Measuring between IAC Valve TER A and D
20-100	Measuring between IAC Valve TER B and C

P1 VSS

- VSS utilized hole sensor theory:
- VSS signal is detected below 0.5V when VSS transistor is operated.
- VSS signal is detected about 12V when the transistor is not operated.

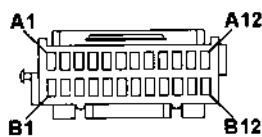

ECM CONNECTOR



COOLANT TEMP. SENSOR CONNECTOR



MAP SENSOR CONNECTOR



THROTTLE POSITION SENSOR CONNECTOR



IDLE AIR CONTROL VALVE CONNECTOR



O₂ SENSOR CONNECTOR

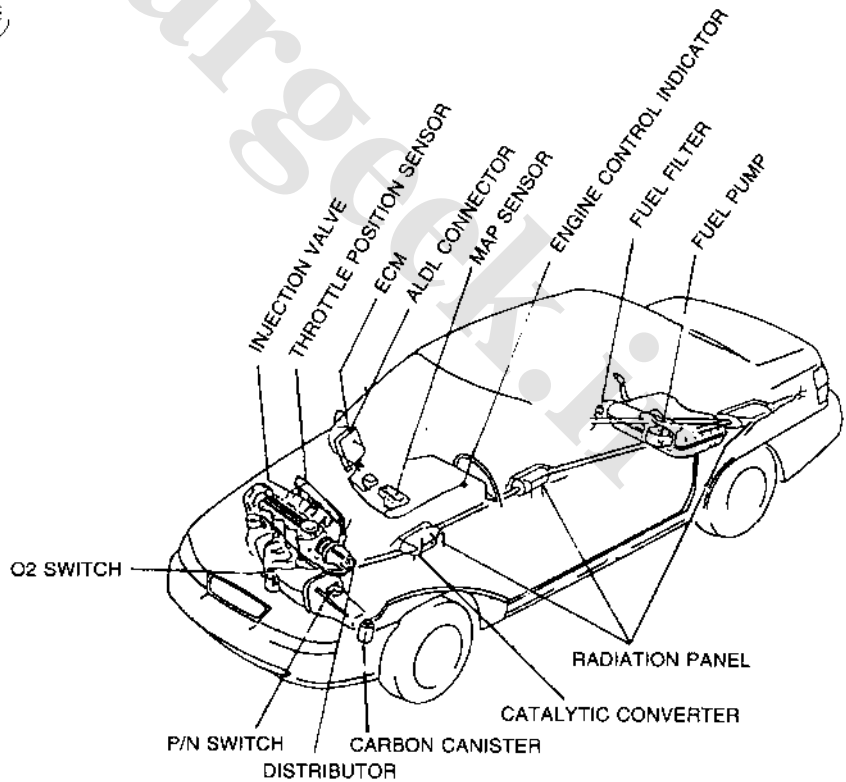
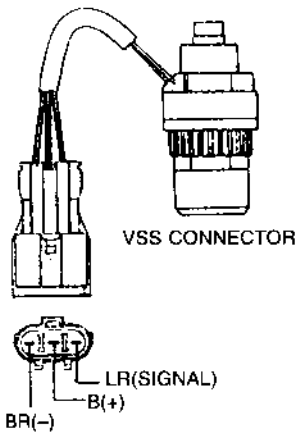
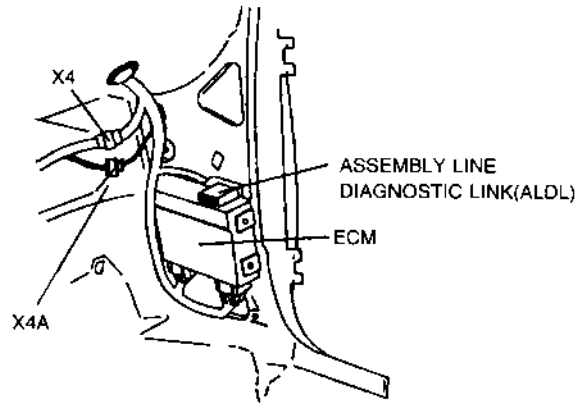
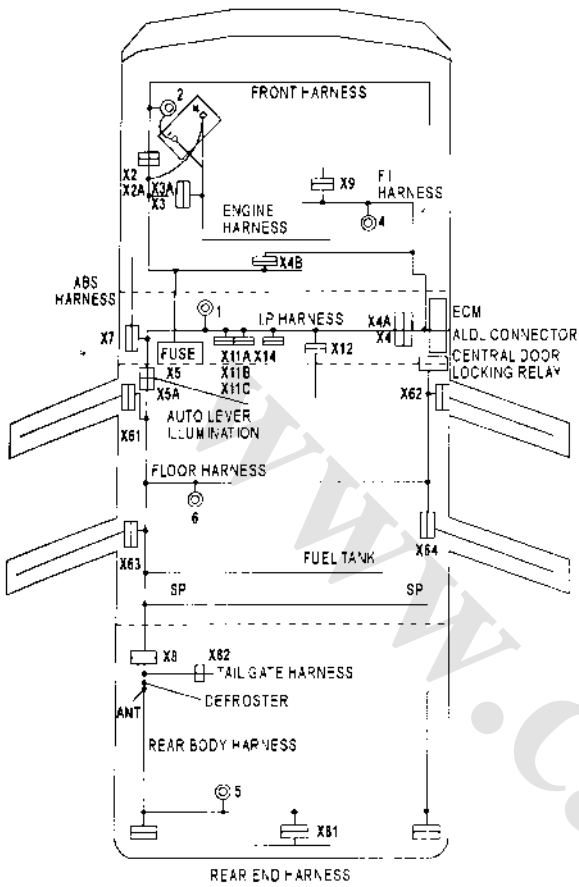

5) "SERVICE ENGINE SOON" LIGHT, FUEL PUMP, ALDL TESTER WIRING(IEFI-6)

- K1 ECM
- M3 FUEL PUMP MOTOR
- S3 P/N SWITCH
- S4 OIL PRESSURE SWITCH
- X1 ALDL CONNECTOR
- X2 FUEL PUMP TEST CONNECTOR
- K2 FUEL PUMP RELAY

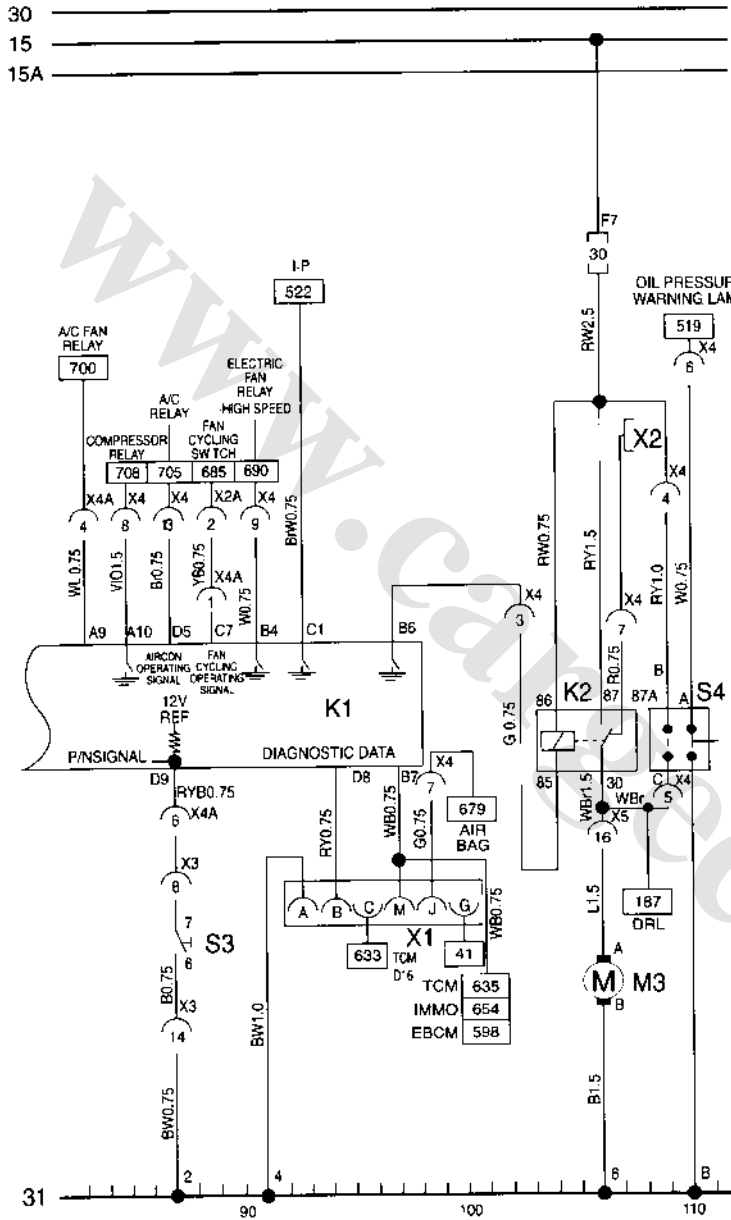

- S3 P/N Switch
A cross-point between A and B in the P/N Switch is "ON" in case that a shift lever is at the P or N Position.
- X1 ALDL Connector
 - Connect Scanner-11
 - On jumpering wire between A and B terminal connecting ALDL key, initial ignition line is controlled or fault codes are identified.
- K1 ECM TER B6
 - Ground is feeded to K2 fuel pump relay for seconds when an ignition key is "ON".
 - During engine in cranking or starting. The ECI detects rpm signal to feed ground to K2 relay.

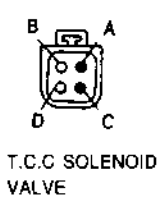
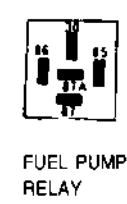
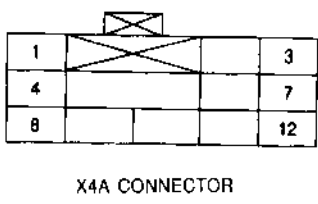
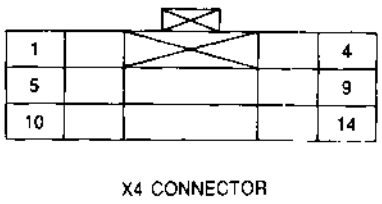
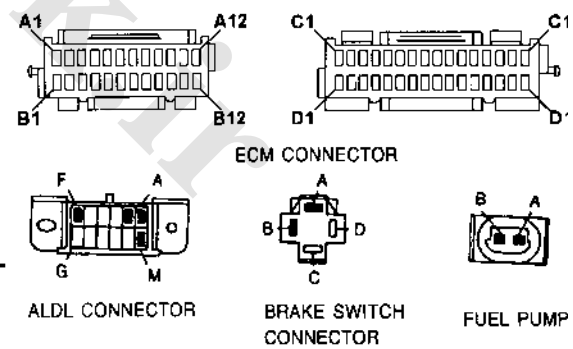

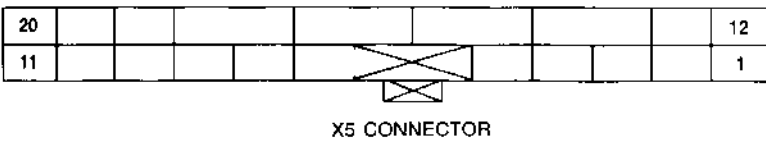
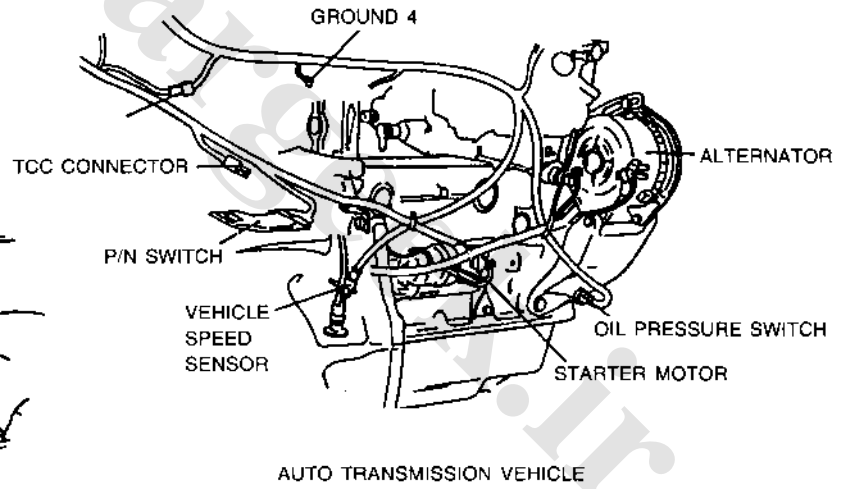
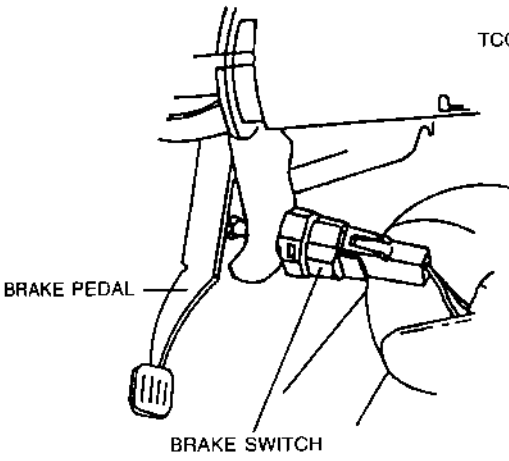
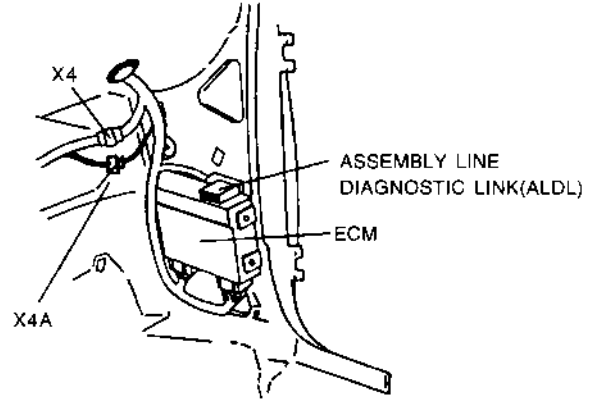
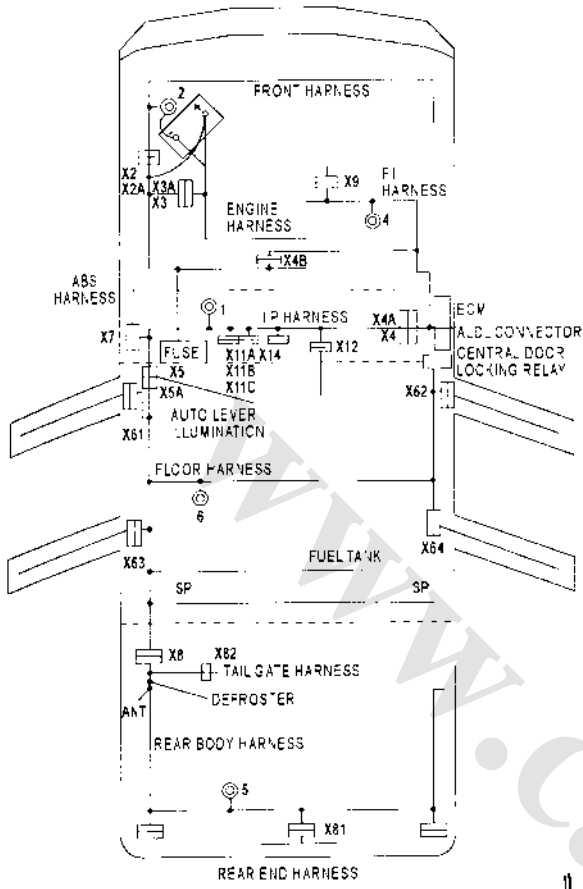

6) IGNITION WIRING(IEFI-S)

- K1 ECM
- L1 IGNITION COIL
- Y1 IGNITION MODULE
- Y2 DISTRIBUTOR

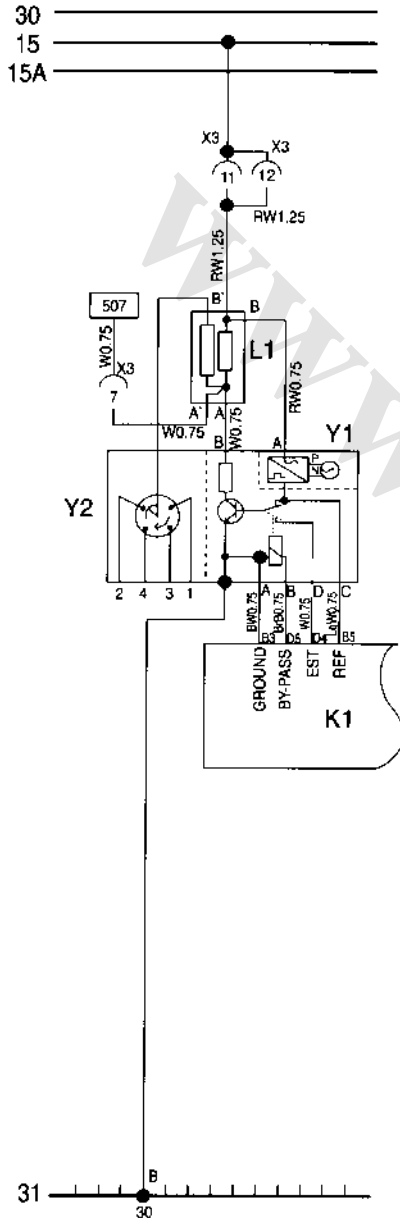

- L1 Ignition Coil
 - Insulation Resistance:∞
 - 1st Resistance: 0.35-0.45ohms
 - 2nd Resistance: 7.5-9.5kilo-ohms
- Y1 Ignition Module
 - Pick up Coil
 - Insulation Resistance:∞
 - Coil Resistance: 500-1500ohms
 - Ignition System Check

Measuring terminal	Cranking	Starting
Ground - Distributor A	0V	0V
Ground - Distributor B	10-20mV	4.5-5.0V
Ground - Distributor C	0.5-1.5V	0.7-2.7V
Ground - Distributor D	0.2-0.3V	1.0-3.0V

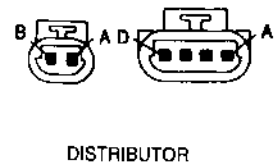
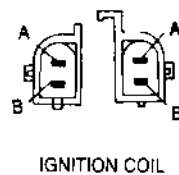
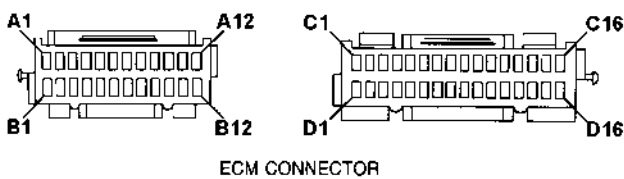

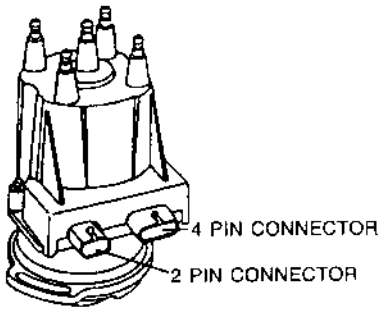
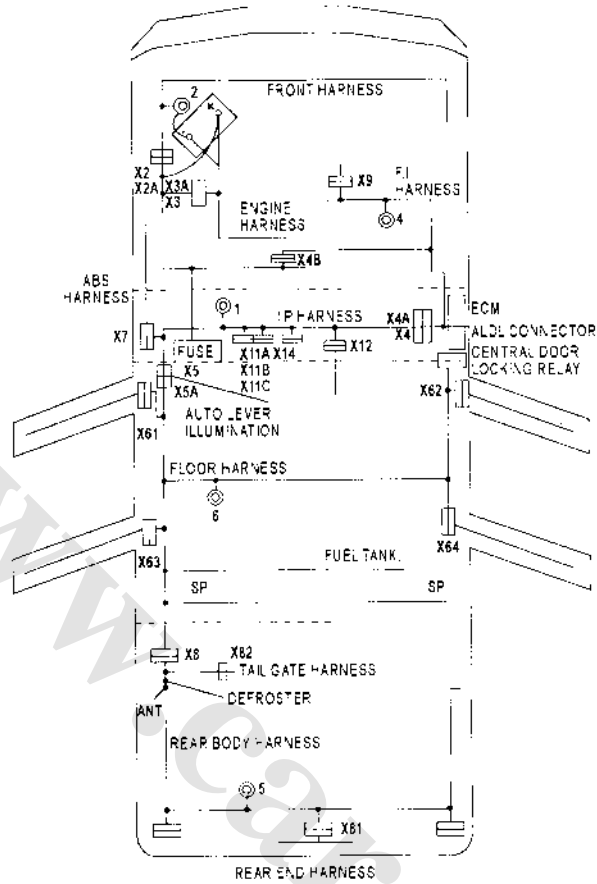

DISTRIBUTOR

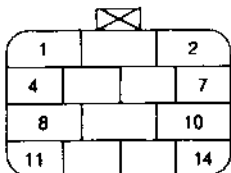
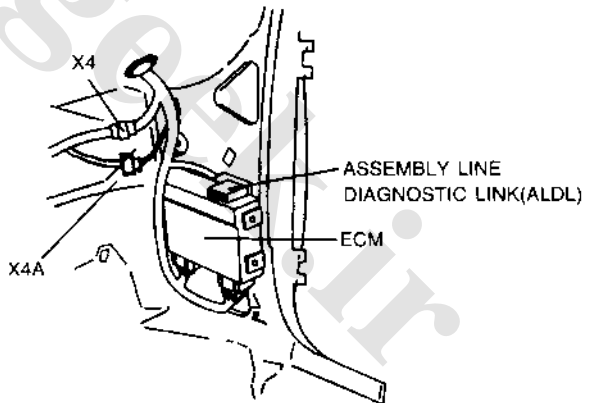

X2, X3 CONNECTOR
(I.P. WIRING HARNESS REFERENCE)

7) INJECTION NOZZLE, ECM POWER, ECM GROUND WIRING(IEFI-S)

K1 ECM
Y3 INJECTOR

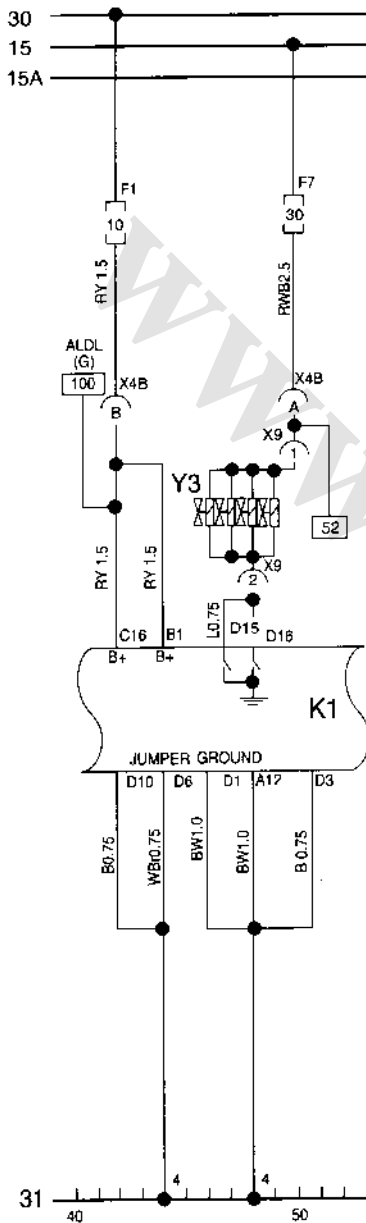

- F1 Fuse Number 1
This is a fuse which always feeds "B+" power to ECM.
If you are to delete a fault code memorized on the ECM. Do as follows:
 - Set Ignition Switch to "OFF" position
 - Disconnect Fuse1 and wait for about 10 seconds
 - Connect Fuse again
- Y3 Injection Valve(Injector)
 - Resistance Valve: 1-2ohms
 - Fuel Pressure: 0.75 bar
- K1 ECM Ground
 - ECM ground is at the terminal of ECM such as A12, D1 and D6.
 - Three ground terminals are at one location which is on the cylinder head.

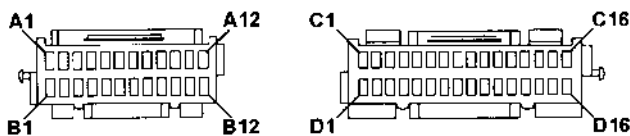

ECM CONNECTOR

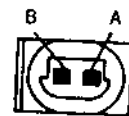

INJECTION VALVE

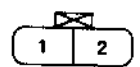

X9 CONNECTOR

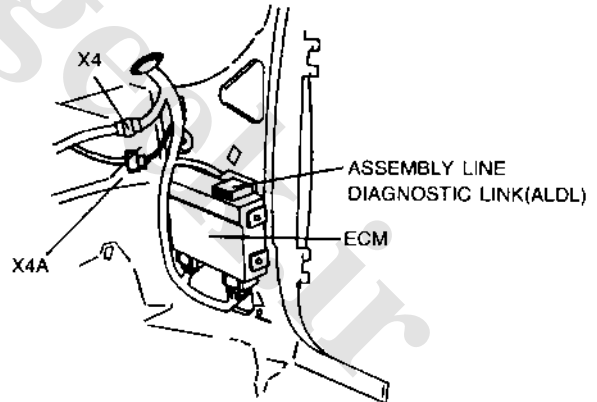
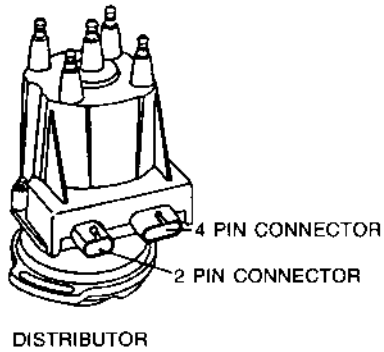
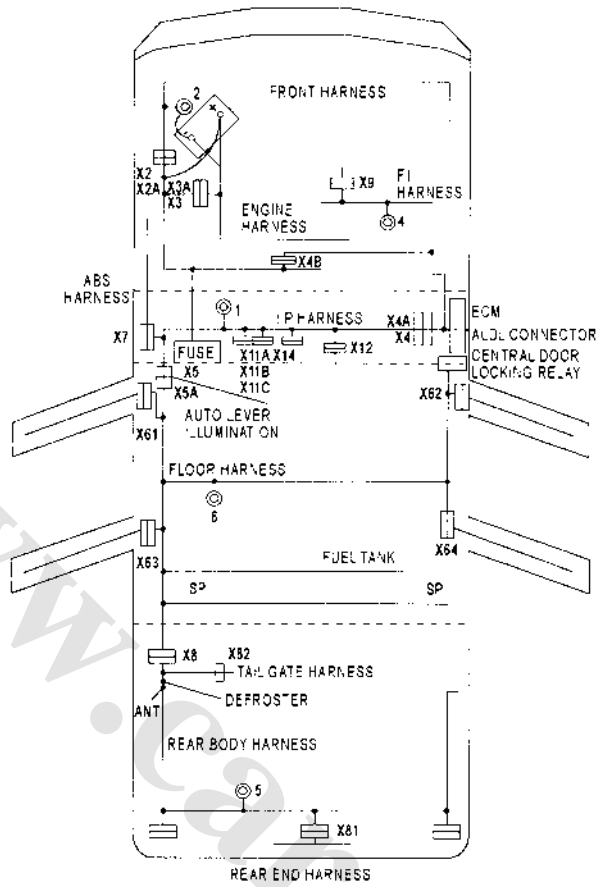

8) COOLANT TEMPERATURE SENSOR(CTS), MANIFOLD AIR PRESSURE(MAP) SENSOR, VEHICLE SPEED SENSOR, THROTTLE POSITION SENSOR(TPS) IAC VALVE, O₂ SENSOR WIRING(IEFI-S)

- K1 ECM
- M2 IDLE AIR CONTROL VALVE(1AC VALVE)
- P1 VEHICLE SPEED SENSOR(VSS)
- P2 COOLANT TEMPERATURE SENSOR(CTS)
- P3 INTAKE MANIFOLD AIR PRESSURE SENSOR(MAP)

- P4 THROTTLE POSITION SENSOR(TPS)
- P5 O₂ SENSOR(UN LEADED TYPE)
- P5-1 O₂ SENSOR(LEADED TYPE)
- P6 MANIFOLD AIR TEMPERATURE SENSOR(MAT)

30 _____
 15 _____
 15A _____

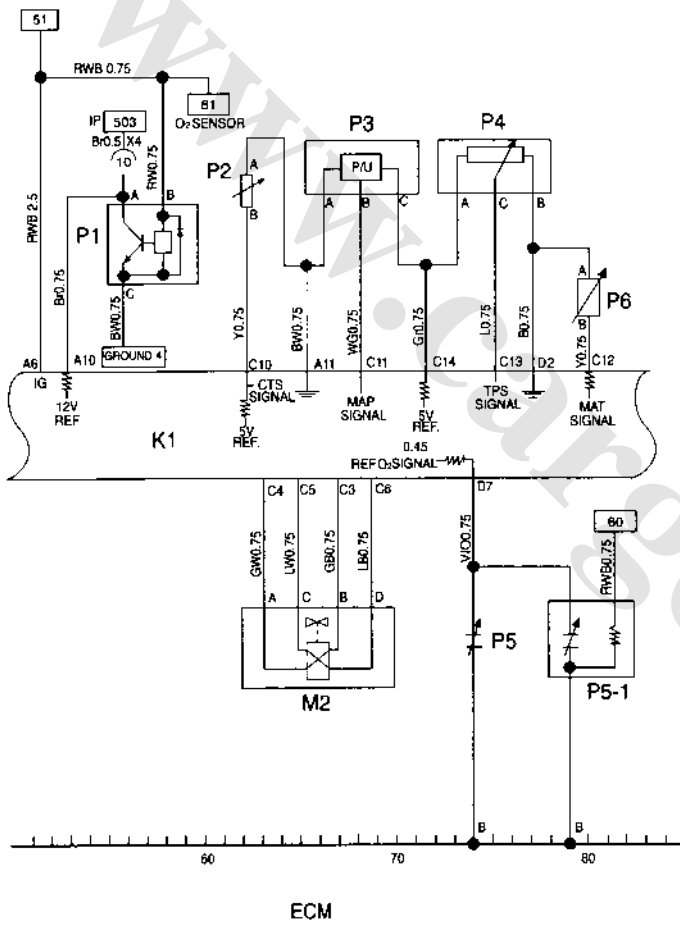

- Fault Code

Stored fault code	Information sensor	Cause of fault
13	Oxygen sensor	No voltage change
14	Coolant temperature sensor	Voltage too high or low
21	Throttle position sensor	Voltage too high or low
23	Manifold air temperature sensor	Voltage too high or low
24	Vehicle speed sensor	No speed impulses
33	Manifold absolute pressure(MAP) sensor	Voltage too high or low
42	Electrical spark advance	No electr. spark advance
44	Oxygen sensor	Air/fuel mixture too lean
45	Oxygen sensor	Air/fuel mixture too rich
51	ECM	ECM/EPROM fault

- How to check a fault code

- If the "Service Engine Soon" indicator lights up while driving the engine, a fault has occurred to electronic control system.
- Trouble code can be obtained by flashing the "Service Engine Soon" light if jumpering ALDL terminal "B" to "A" (using ALDL key) with the ignition "ON".
- To erase the trouble code, disconnect fuse #1 for 10 seconds with ignition switch "OFF".

- P2 Coolant Temperature Sensor(CTS)

Temperature(°C)	Resistance(kilo-ohms)
100	0.165
70	0.45
20	3.4
-4	7.5
-40	100

- P3 Intake manifold Air Pressure Sensor(MAP)

Pressure(bar)	MAP signal voltage(v)	Remarks
-0.2	3.7±0.2	Measuring at the Ter A and Ter B of MAP
-0.4	2.5±0.2	Measuring at the Ter A and Ter B of MAP
-0.6	1.5±0.2	Measuring at the Ter A and Ter B of MAP
-0.8	0.5±0.2	Measuring at the Ter A and Ter B of MAP

- P4 Throttle Position Sensor(TPS)

Throttle valve opening(%)	Resistance (kilo-ohms)	Signal Voltage(V)	Remarks
0	2±1	0.5±0.2	Measuring between the TPS Ter B and C
50	3.5±1	2.5±0.2	
100	6.5±1	4.5±0.2	

- P5 O₂ Sensor

- Voltage is changed between 0.1 and 0.9V
- M2 Idle Air Control Valve(IAC Valve)
- Idle RPM speed: 800-850 RPM

Resistance(ohms)	Remarks
20-100	Measuring between IAC Valve TER A and D
20-100	Measuring between IAC Valve TER B and C

- P1 VSS

- VSS utilized hole sensor theory:
- VSS signal is detected below 0.5V when VSS transistor is operated.
- VSS signal is detected about 12V when the transistor is not operated.

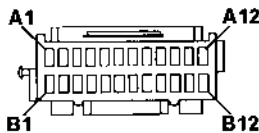

ECM CONNECTOR

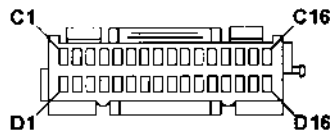

COOLANT TEMP. SENSOR CONNECTOR

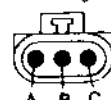

MAP SENSOR CONNECTOR

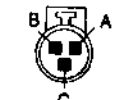

THROTTLE POSITION SENSOR CONNECTOR



IDLE AIR CONTROL VALVE CONNECTOR



O₂ SENSOR CONNECTOR

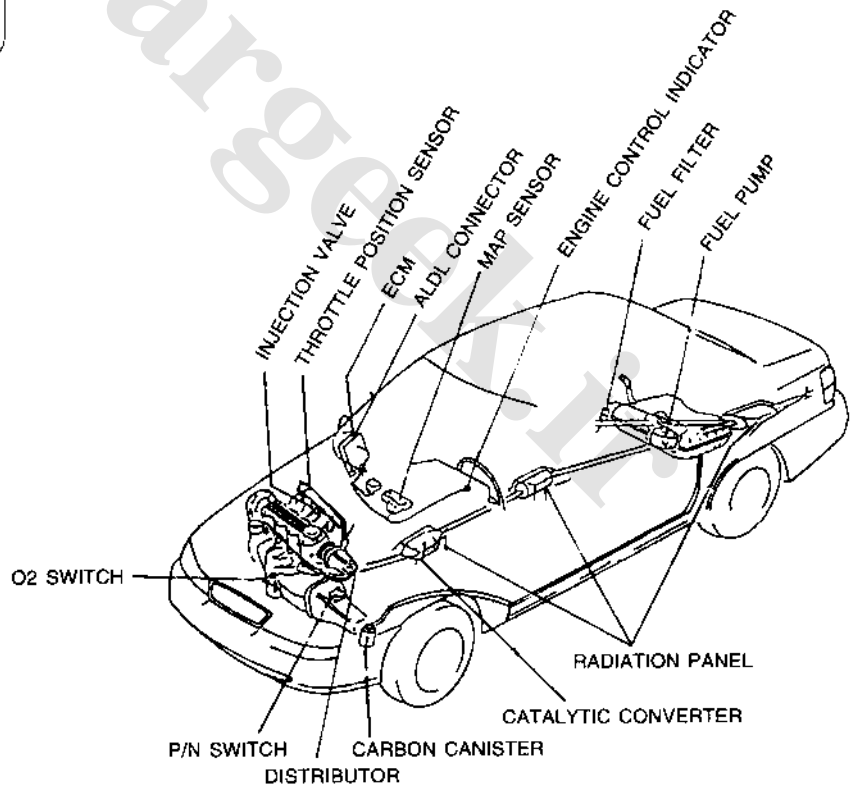
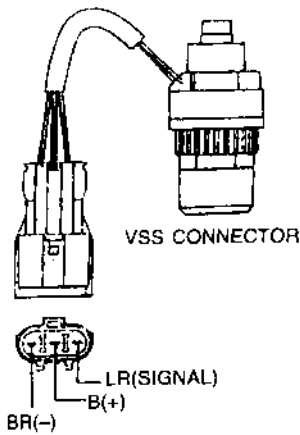
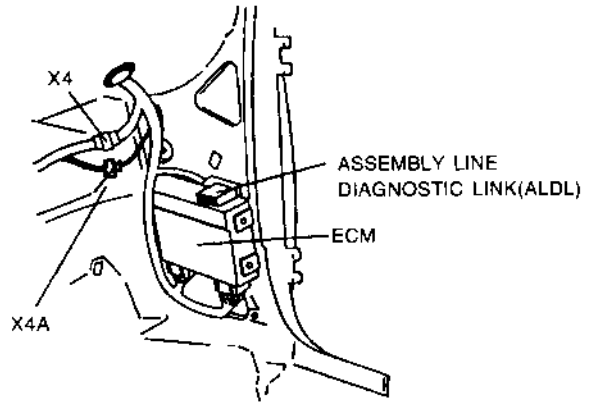
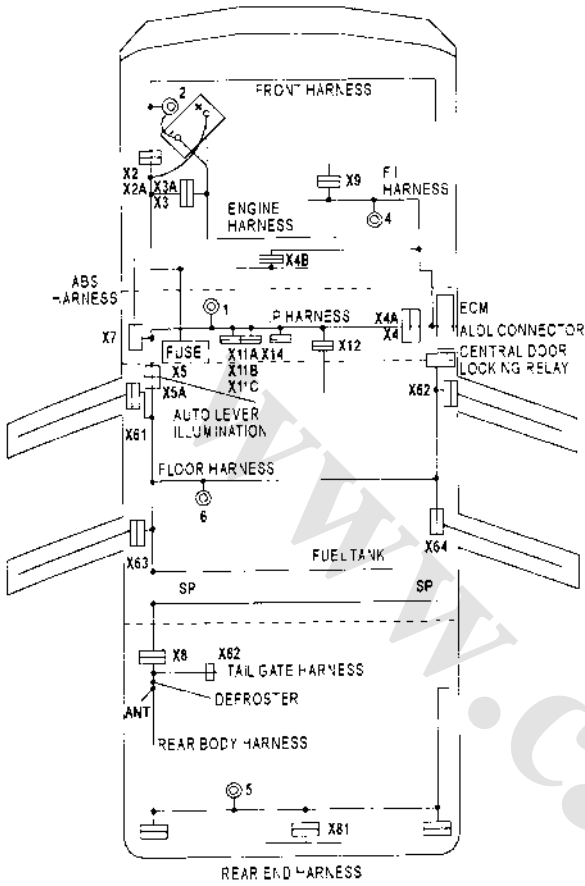

9) "SERVICE ENGINE SOON" LIGHT, TCC, FUEL PUMP, ALDL TESTER WIRING(IEFI-S)

- K1 ECM
- K2 FUEL PUMP RELAY
- M3 FUEL PUMP MOTOR
- S3 BRAKE SWITCH
- S4 OIL PRESSURE SWITCH
- S2 P/N SWITCH
- X1 ALDL CONNECTOR
- X2 FUEL PUMP TEST CONNECTOR
- Y4 TCC SOLENOID VALVE (AUTO T/M 3-SPEED)

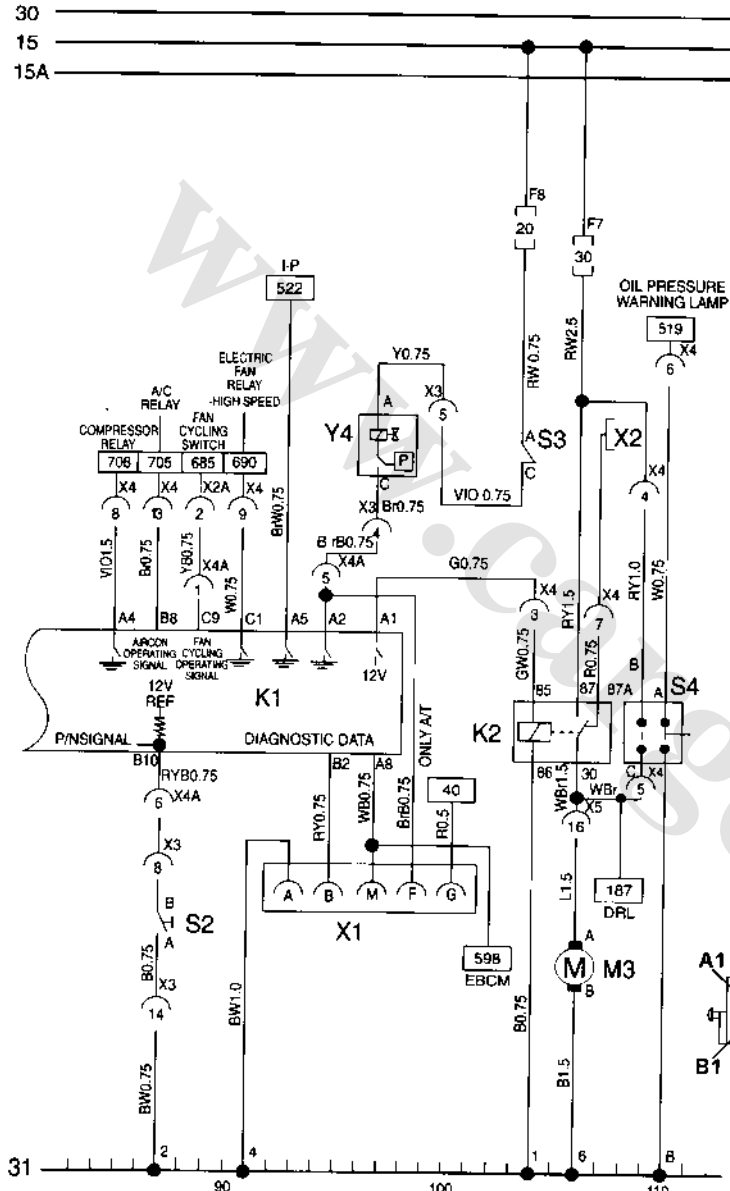

- S2 P/N Switch
A cross-point between A and B in the P/N Switch is "ON" in case that a shift lever is at the P or N Position.
- K1 ECM Ter. A1
• B+ power is feeded to K2 fuel pump relay for 2 seconds when an ignition switch is "ON".
• During engine in cranking or starting, the ECM detects RPM signals to feed B+ power to K2 Relay.
- X1 ALDL Connector
• Connect Scanner-1
• On jumpering wire between A and B terminal or connecting ALDL key, initial ignition line is controlled or fault codes are identified.

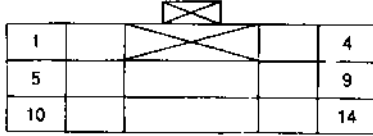

X4 CONNECTOR

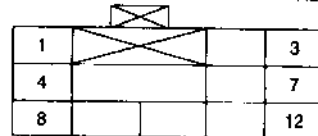

X4A CONNECTOR

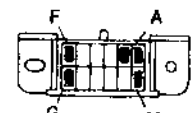

FUEL PUMP RELAY

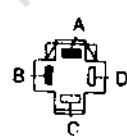

BRAKE SWITCH CONNECTOR

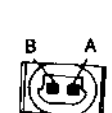

FUEL PUMP



FUEL PUMP RELAY

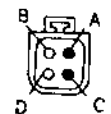

T.C.C SOLENOID VALVE

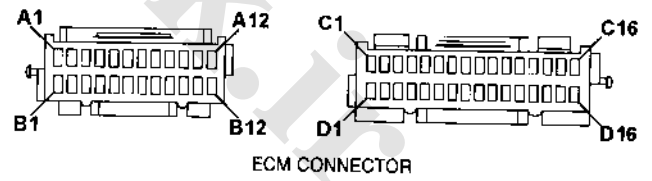

ECM CONNECTOR

10) LIGHT WIRING

- E1 HEAD LAMP HIGH BEAM(LEFT)
- E2 HEAD LAMP LOW BEAM(LEFT)
- E3 HEAD LAMP HIGH BEAM(RIGHT)
- E4 HEAD LAMP LOW BEAM(RIGHT)
- K3 ILLUMINATION RELAY
- K4 HEAD LAMP RELAY
- M4 HLLD MOTOR(LEFT)
- M5 HLLD MOTOR(RIGHT)
- R2 HEAD LAMP LEVELING DEVICE(HLLD) CONTROL UNIT
- S5 LIGHT SWITCH
- S6 DIMMER SWITCH

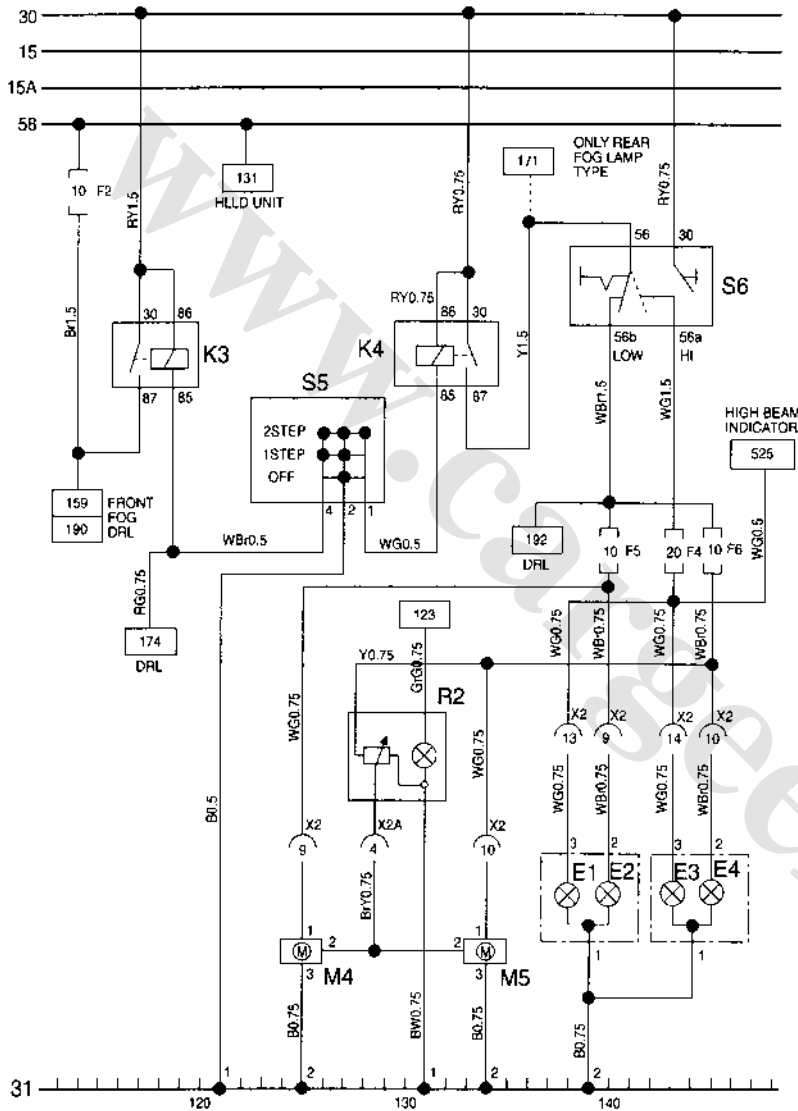

- F2 58 Line
After a light switch is set to 1st or 2nd step, a illumination relay is operating to feed power to Fuse 2.
The line connect to F2 is called a 58 Line.
The 58 Line feeds power to various Illumination lamps and clearance lamps, etc.
- S5 Switch, S6 Dimmer Switch
A light Switch and A dimmer switch are display respectively on the wiring diagram.
But these are assembled physically in a device.
- [525] Analog, Instrument panel.
This is connected to I/P Head Lamp high beam Indicator.

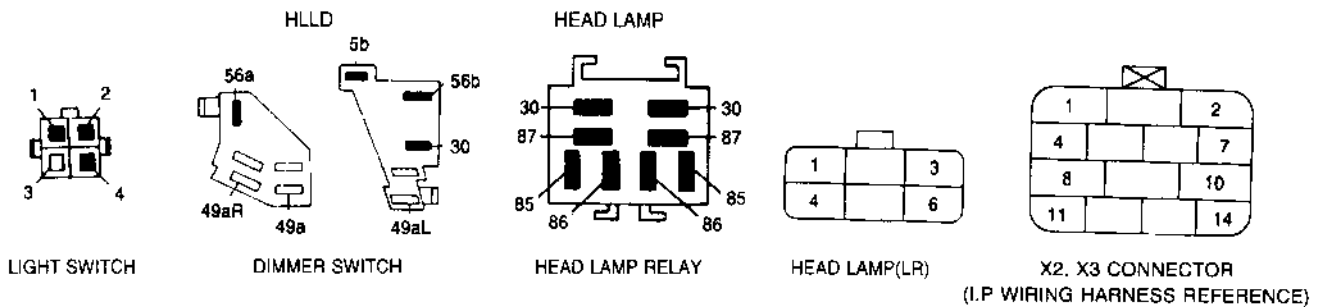

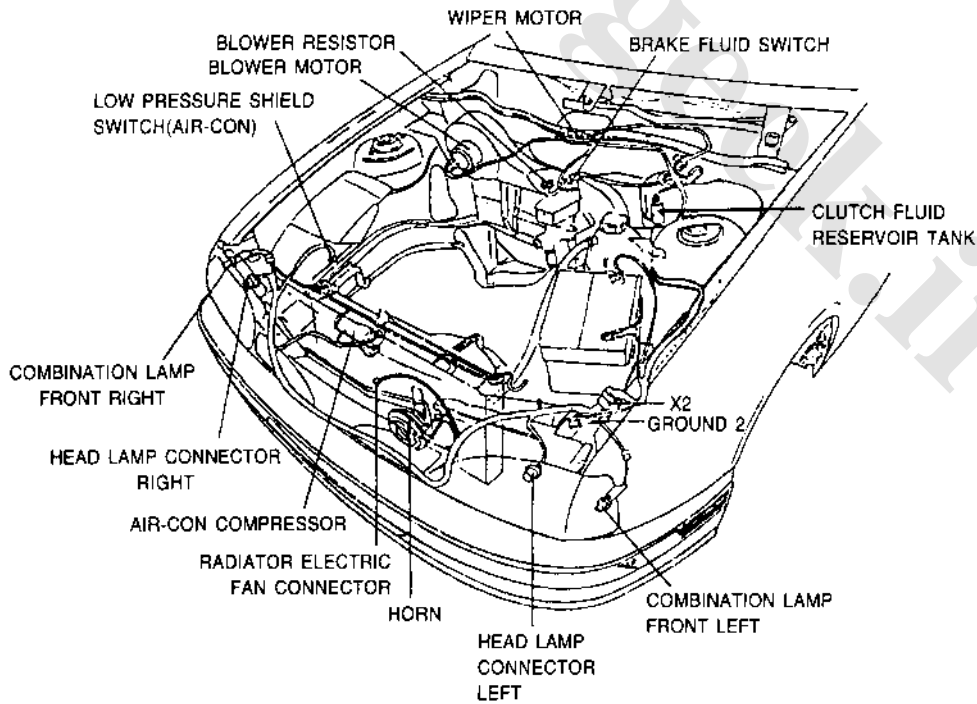
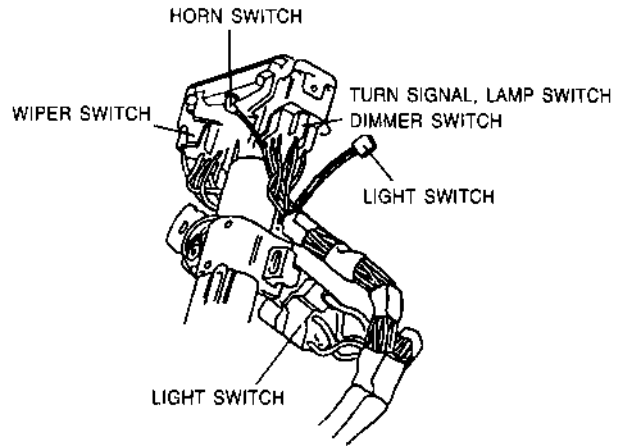
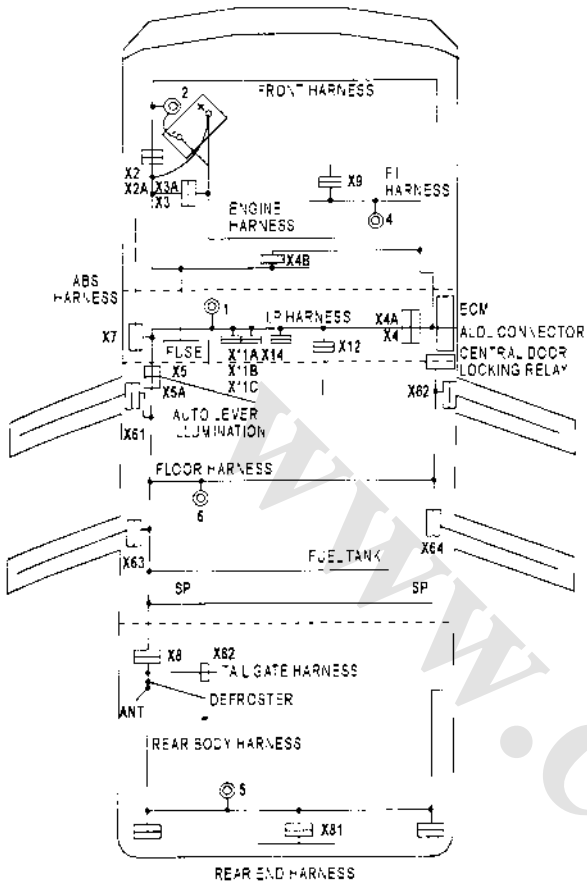

11) FRONT FOG LAMP & REAR FOG LAMP

- E5 FRONT FOG LAMP(LEFT)
- E6 FRONT FOG LAMP(RIGHT)
- E7 REAR FOG LAMP(LEFT)
- E8 REAR FOG LAMP(RIGHT)
- K5 FRONT FOG LAMP RELAY
- S7 FRONT FOG LAMP SWITCH
- S8 REAR FOG LAMP SWITCH
- S8-1 REAR FOG LAMP SWITCH (REAR FOG LAMP TYPE ONLY)
- E7-1 REAR FOG LAMP (LEFT) (REAR FOG LAMP TYPE ONLY)
- E8-1 REAR FOG LAMP (RIGHT) (REAR FOG LAMP TYPE ONLY)

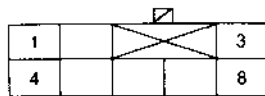
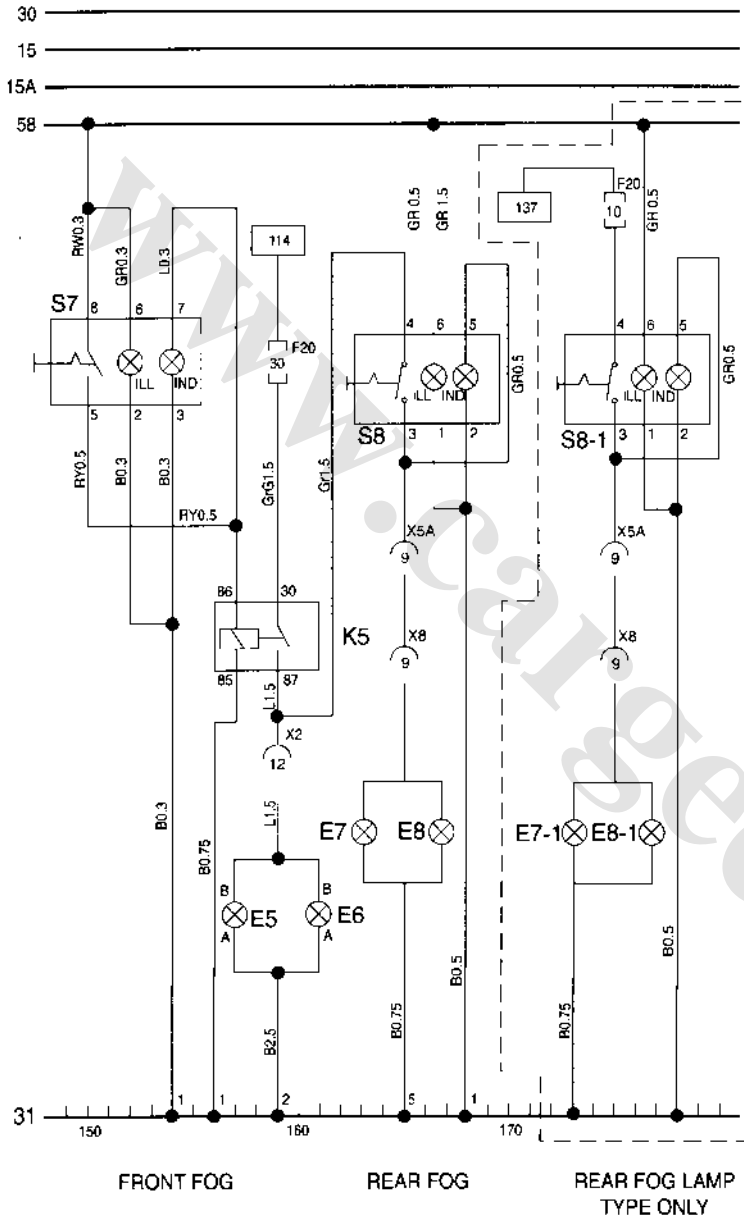

FRONT FOG S/W

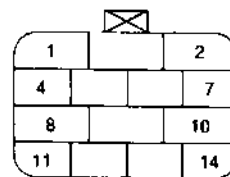

X2, X3 CONNECTOR
(I.P WIRING HARNESS REFERENCE)

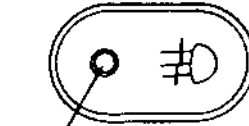
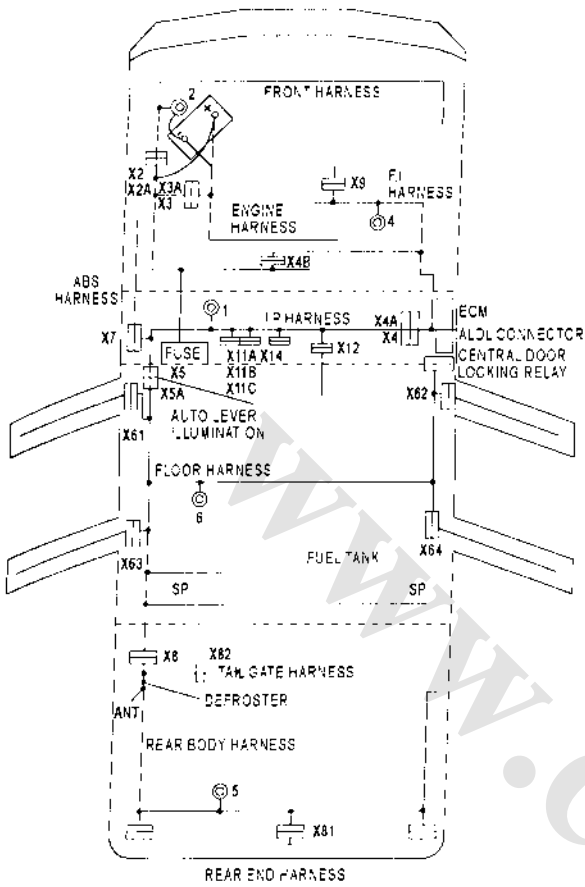

INDICATOR

FRONT FOG LAMP S/W

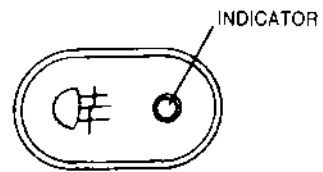

INDICATOR

REAR FOG LAMP S/W

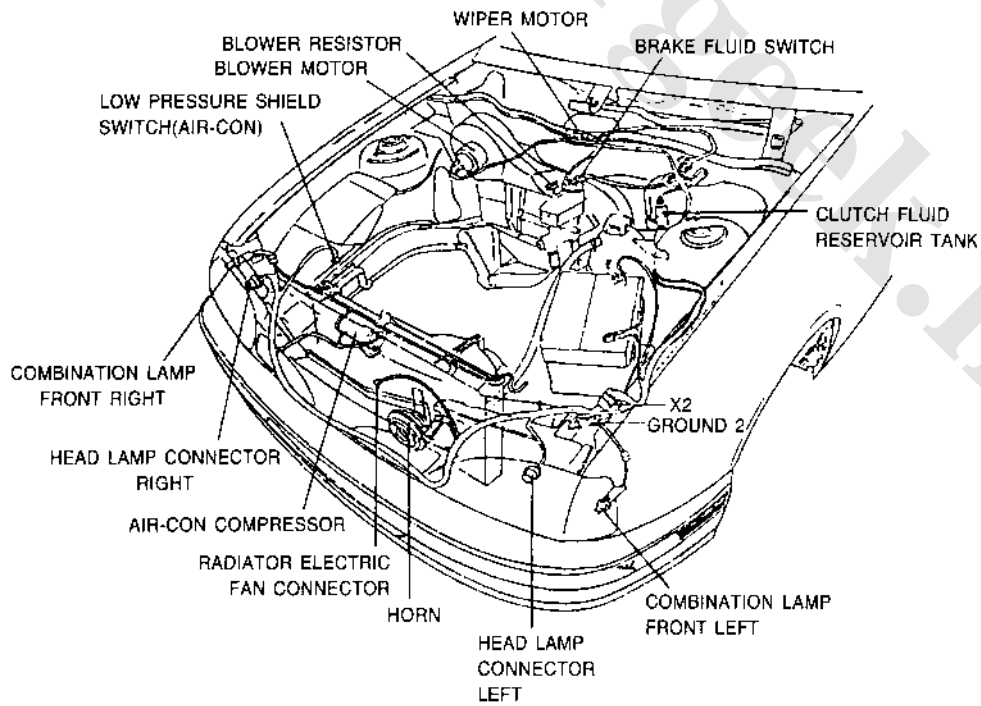

12) DAY TIME RUNNING LIGHT, CLEARANCE LAMP, LICENCE PLATE LAMP, HORN WIRING

- E9 A/T SELECTOR LEVER ILLUMINATION LAMP
- E10 POSITION LAMP(LEFT)
- E11 POSITION LAMP(RIGHT)
- E12 CLEARANCE LAMP(LEFT)
- E13 LICENCE PLATE LAMP
- H1 HORN
- E14 LICENCE PLATE LAMP
- E15 CLEARANCE LAMP(RIGHT)
- K6 DAY TIME RUNNING LIGHT(DRL) RELAY
- K7 DRL CONTROL UNIT
- S9 HORN SWITCH
- K25 HORN RELAY

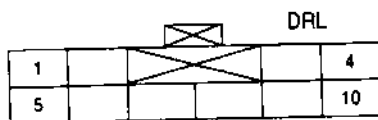
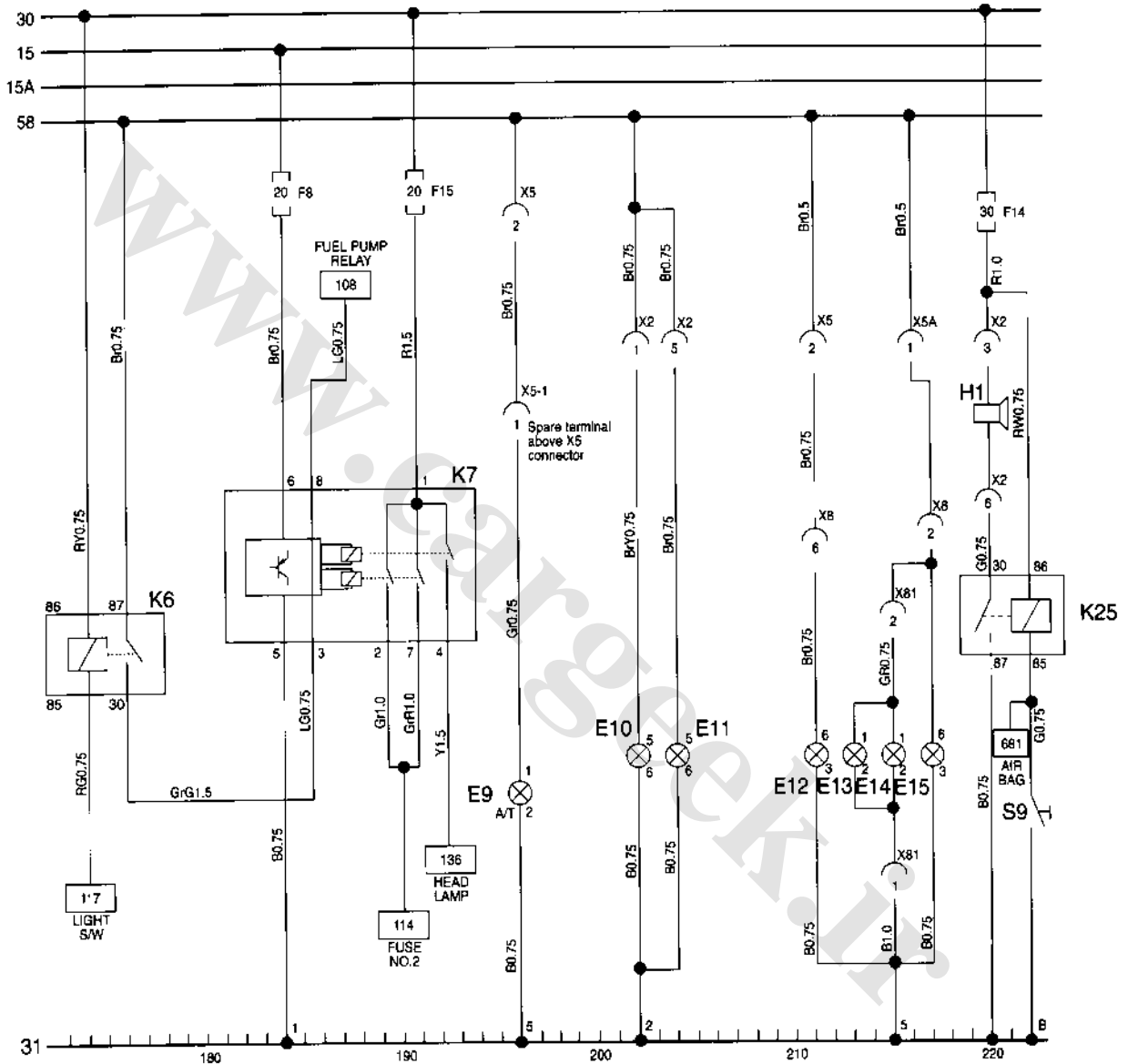

X5A CONNECTOR

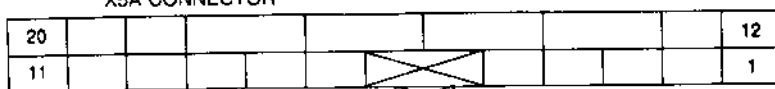

X5 CONNECTOR

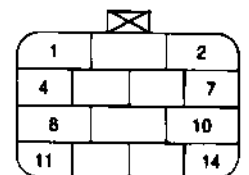

X2, X3 CONNECTOR
(I.P WIRING HARNESS REFERENCE)

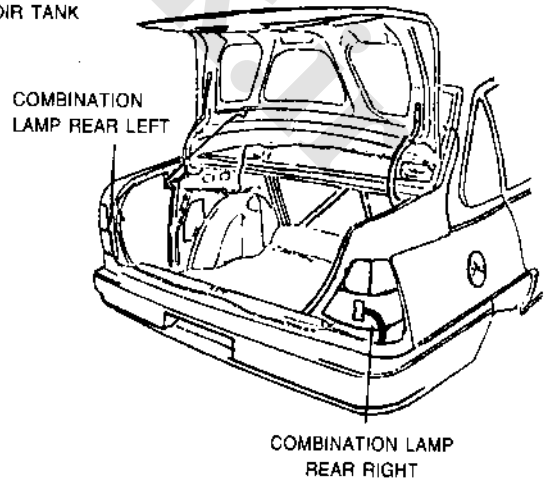
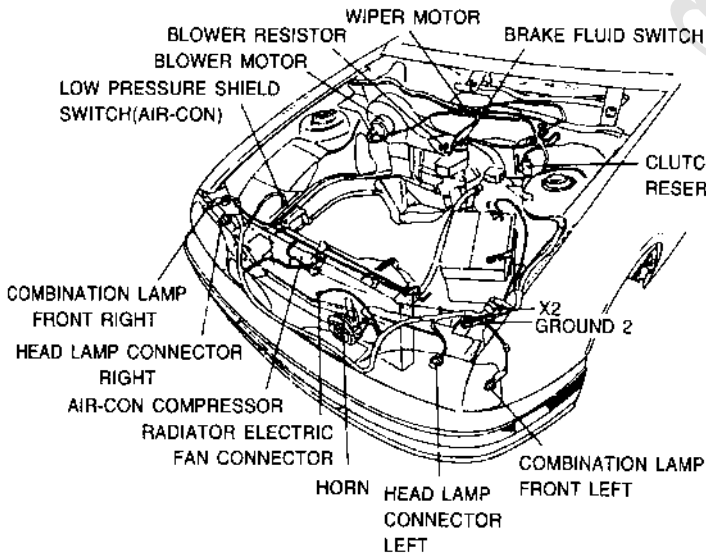
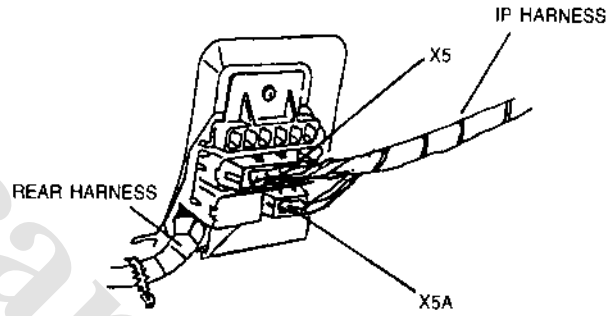
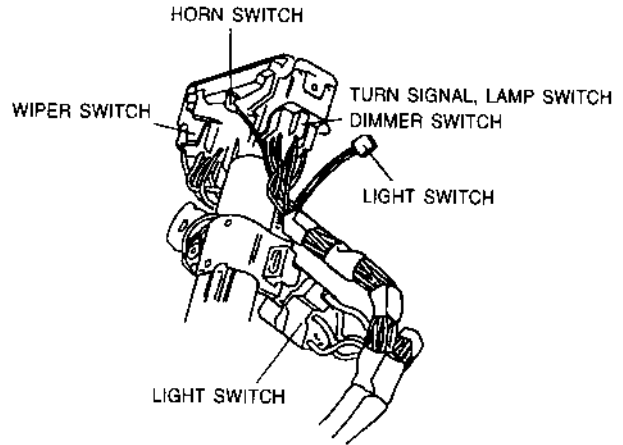
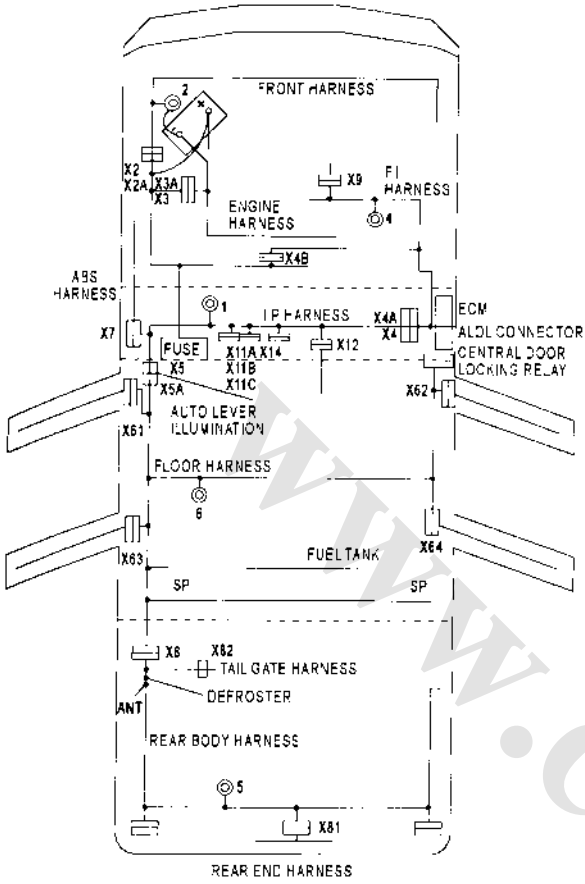

13) GLOVE BOX LAMP, CIGARETTE LIGHTER, DIGITAL CLOCK ROOM LAMP, TRUNK ROOM LAMP, WIRING

- E16 ILLUMINATION LAMP – CIGARETTE LIGHTER
- E17 ILLUMINATION LAMP – ASH TRAY
- E18 TRUNK ROOM LAMP
- E18-1 TRUNK ROOM LAMP(5-DOOR)
- E19 ROOM LAMP
- E49 GLOVE BOX ILLUMINATION LAMP
- H2 DIGITAL CLOCK

- R3 CIGARETTE LIGHTER
- S10 GLOVE BOX ILLUMINATION SWITCH
- S11 TRUNK ROOM LAMP SWITCH(5-DOOR)
- S12 DOOR CONTACT SWITCH-R.R
- S13 DOOR CONTACT SWITCH-R.L
- S14 DOOR CONTACT SWITCH-F.R
- S15 DOOR CONTACT SWITCH-F.L

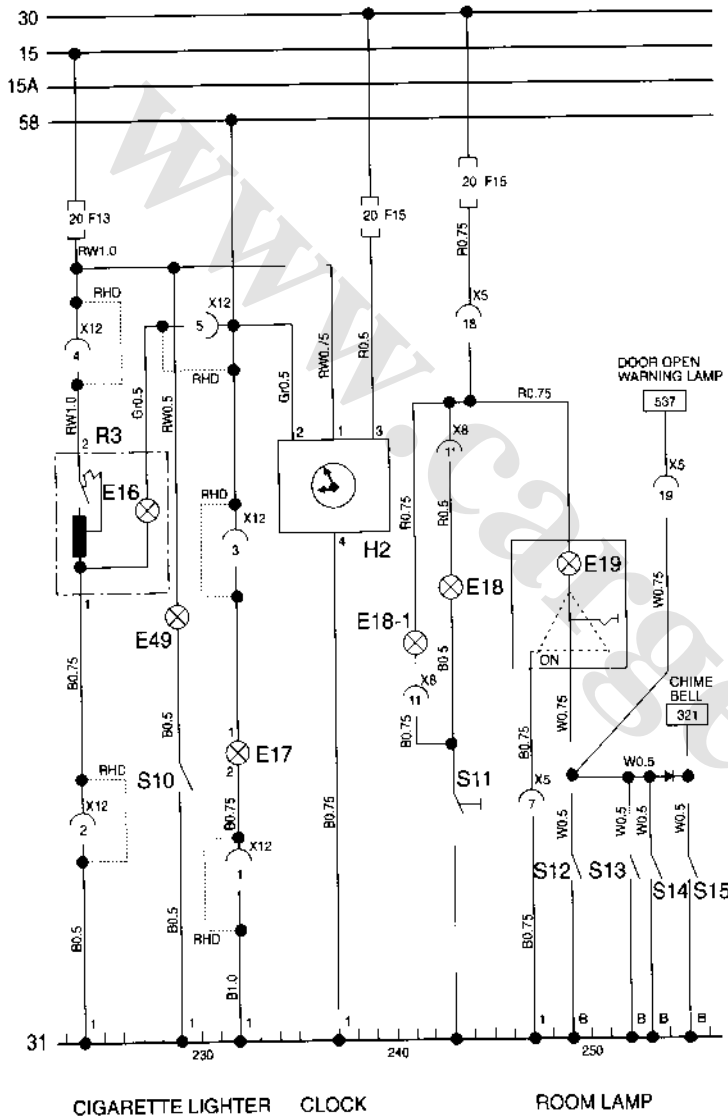

- H2 Digital Clock
 - The power operating a clock is H2 digital clock terminal 3 supplied B+ and H2 digital clock terminal 4 connected to ground line.
 - H2 digital clock terminal 1 is feeded from 15 line through fuse 13. The 15 line is connected to an illumination lamp when an ignition switch is "ON".
 - H2 digital clock terminal 2 is feeded from 58 line and this is a circuit for controlling brightness of an illumination lamp when light switch is on the first step.
- How to adjust a digital clock
 - "H" hour adjusting(an ignition switch is "ON") adjust hour by pushing the "H" button. It is adjusted fastly pushing continuously but done by one hour at one time.
 - "M" minute adjusting(an ignition switch is "ON") adjust minute by pushing the "M" button. On pushing continuously be adjusted fastly but on pushing onetime, be done by one minute.
 - "S" minute setting
On pushing this button, minute become zero.
 - "DISP" display button
When an ignition switch is "OFF" position, time is displayed in case of pushing this button.

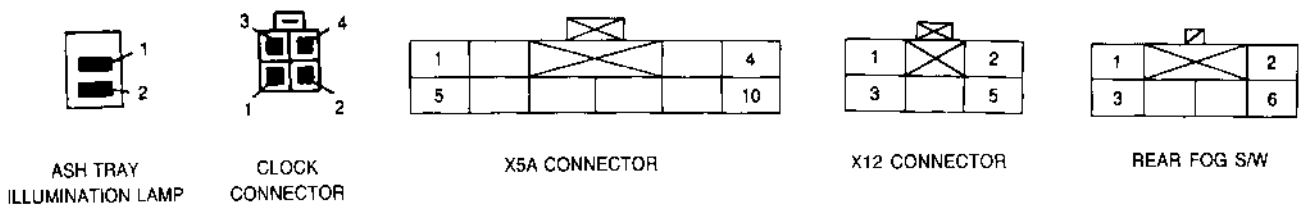
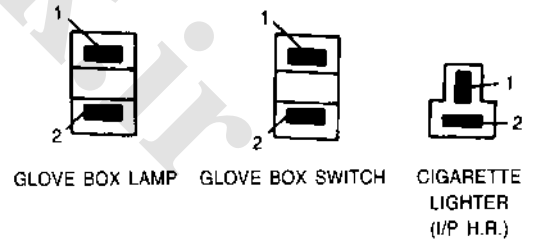

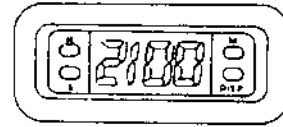
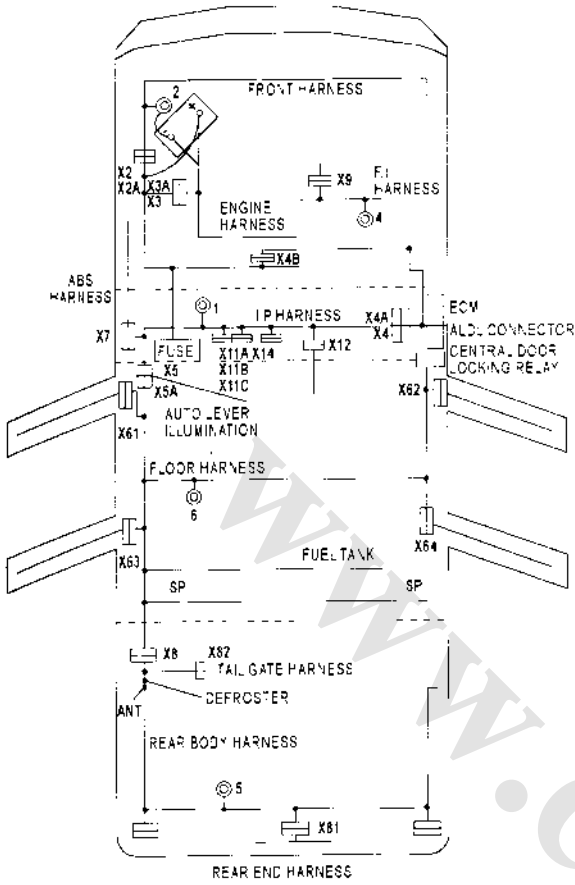

DIGITAL CLOCK

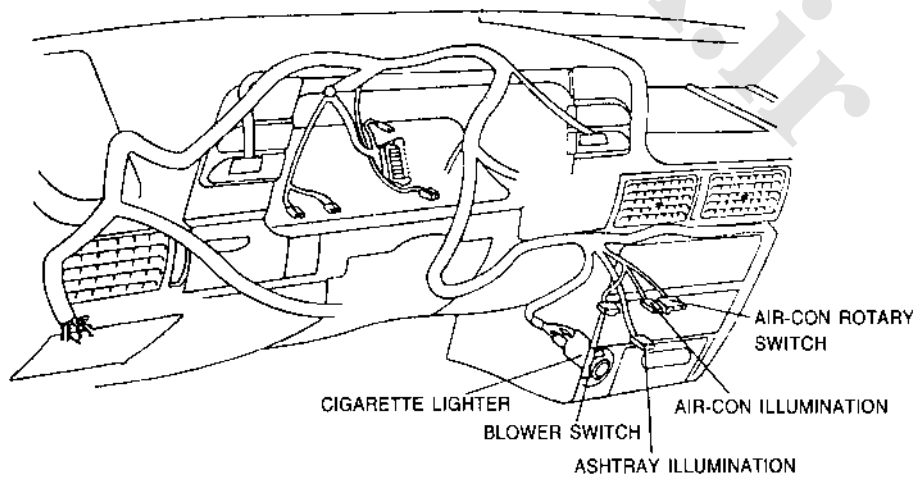
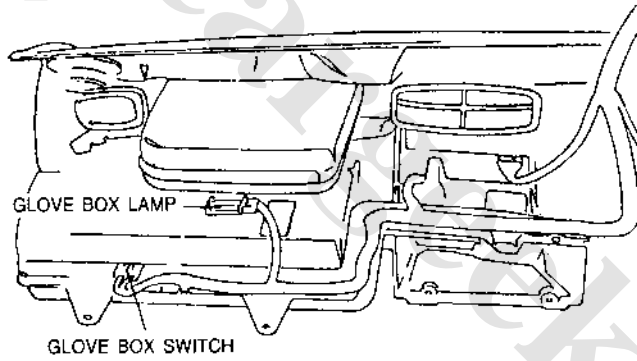

14) BRAKE LAMP, REVERSE LAMP, TCC WIRING

- E20 BRAKE LAMP(LEFT)
- E20-1 CENTER HIGH MOUNTING
BRAKE LAMP(3-DOOR,5-DOOR)
- E21 BRAKE LAMP(RIGHT)
- E22 REVERSE LAMP(LEFT)

- E23 REVERSE LAMP(RIGHT)
- S2 P/N SWITCH(3AT)
- S2-1 P/N SWITCH(4AT)
- S16 BRAKE SWITCH(M/T)

- S17 BRAKE SWITCH(3AT)
- S18 REVERSE LAMP SWITCH(MT)
- X1 ALDL CONNECTOR
- Y4 TCC SOLENOID VALVE

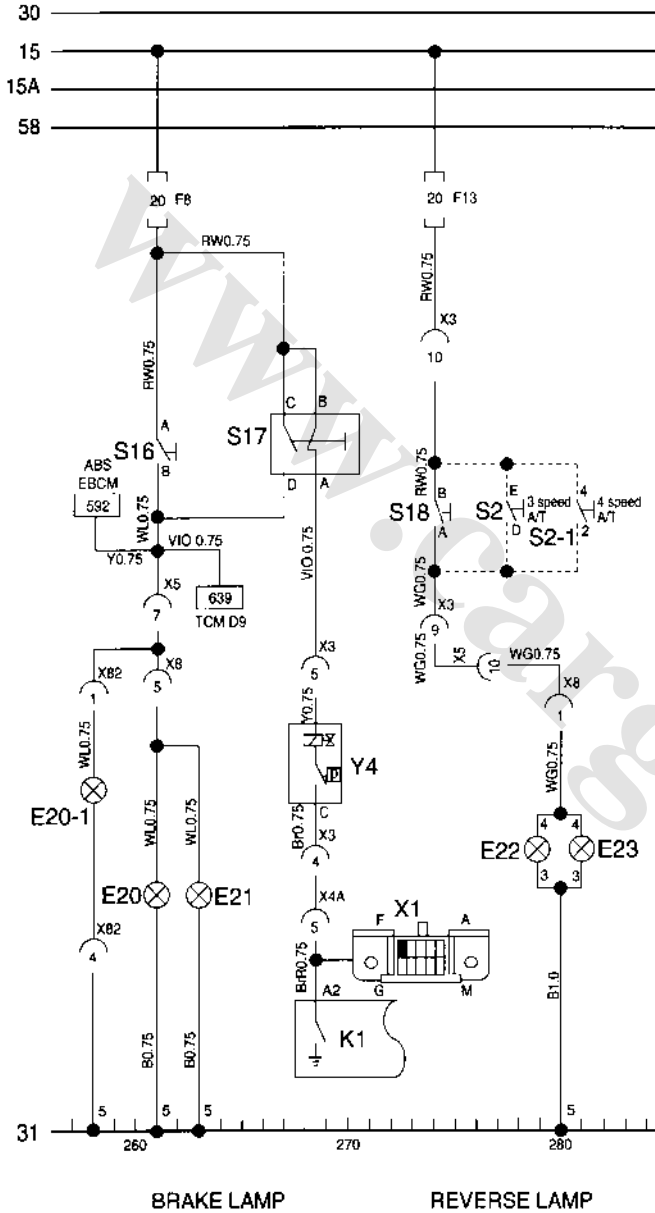

- S2 P/N Switch(A/T)
"D" and "E" Terminal of P/N Switch is "ON" when Selector Switch is at the R position.
- S17 Brake Switch(A/T)
A brake Switch for A/T has four terminals. A and B terminals are always "on" and then "off" on braking the pedal. Because this is connected to TCC Controller. TCC is released on braking. C and D terminals are "ON" during being braked.
- S16 Brake Switch(M/T)
A break switch for M/T has two terminals. When braking a cross point of A and B is "ON" and Brake system Warning Light is ON.
- S18 Reverse Lamp Switch(M/T)
A Reverse Switch – installed on the trans axle – has two cross points. A cross point is "ON" only when a shift lever is at R position.
- K1 ECM Ter A2(3A/T)
ECM actuates Torque Converter Clutch Solenoid valve under the TCC operating Condition.
 - TCC operating condition is as follows:
 - 1) Brake pedal is off.
 - 2) When Oil pressure switch is closed to operate 3 step gear.
 - 3) When the throttle valve opening percentage is constant.
 - 4) When coolant temperature is over about 70°C.
 - 5) When vehicle speed is over 41km/h.
 - Reference
ECM Terminal A2 is used for controlling TCC in case of A/T, and for controlling a shift-up indicator in case of M/T respectively.

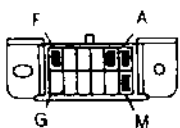

ALDL CONNECTOR

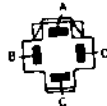

BRAKE SWITCH CONNECTOR

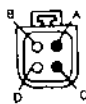

T.C.C SOLENOID VALVE

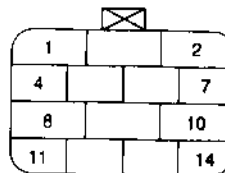

X3 CONNECTOR

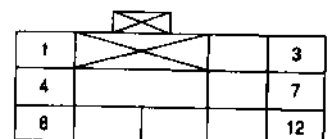

X4A CONNECTOR

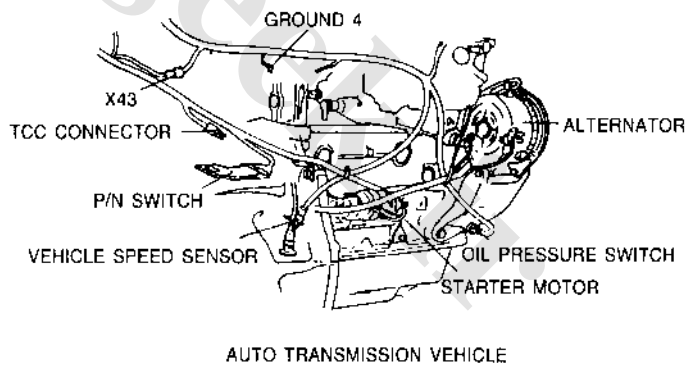
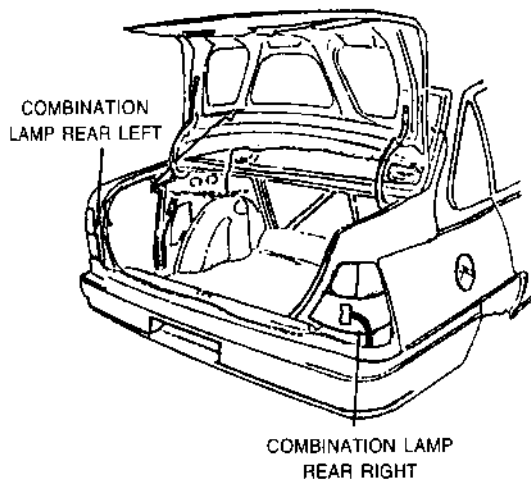
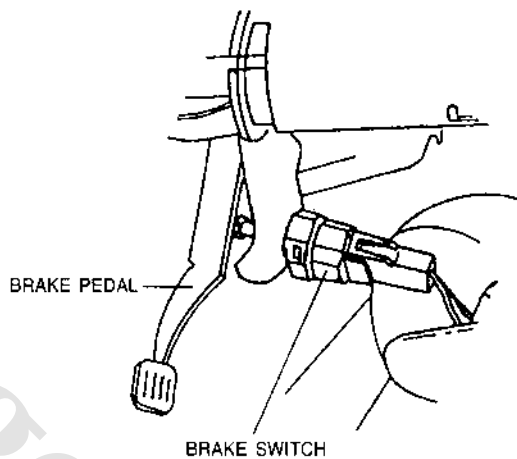
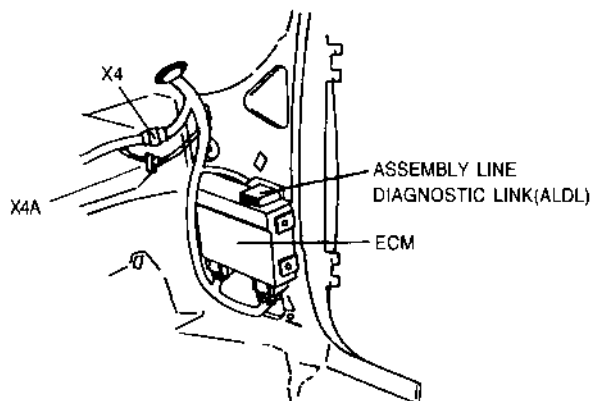
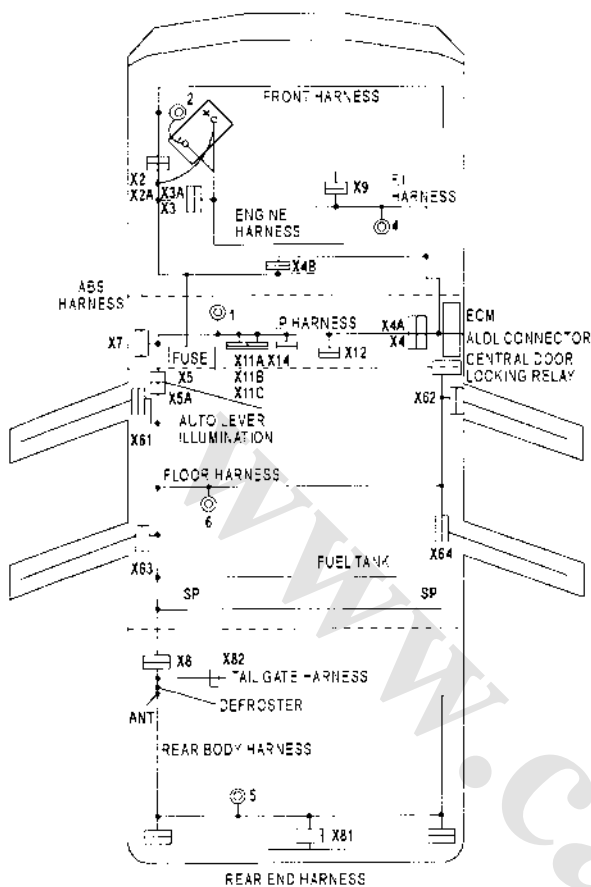

1			4
5			9
10			14

X8 CONNECTOR

20							12
11							1

X5 CONNECTOR

15) TURN SIGNAL LAMP, HAZARD LAMP WIRING

- E24 ILLUMINATION LAMP - HAZARD LAMP SWITCH
- E25 ADDITIONAL TURN SIGNAL LAMP(LEFT)
- E26 TURN SIGNAL LAMP-R.L
- E27 TURN SIGNAL LAMP-F.L
- E28 TURN SIGNAL LAMP-F.R

- E29 TURN SIGNAL LAMP-R.R
- E30 ADDITIONAL TURN SIGNAL LAMP-RIGHT
- K8 TURN SIGNAL LAMP RELAY
- S19 HAZARD LAMP SWITCH
- S20 TURN SIGNAL LAMP SWITCH

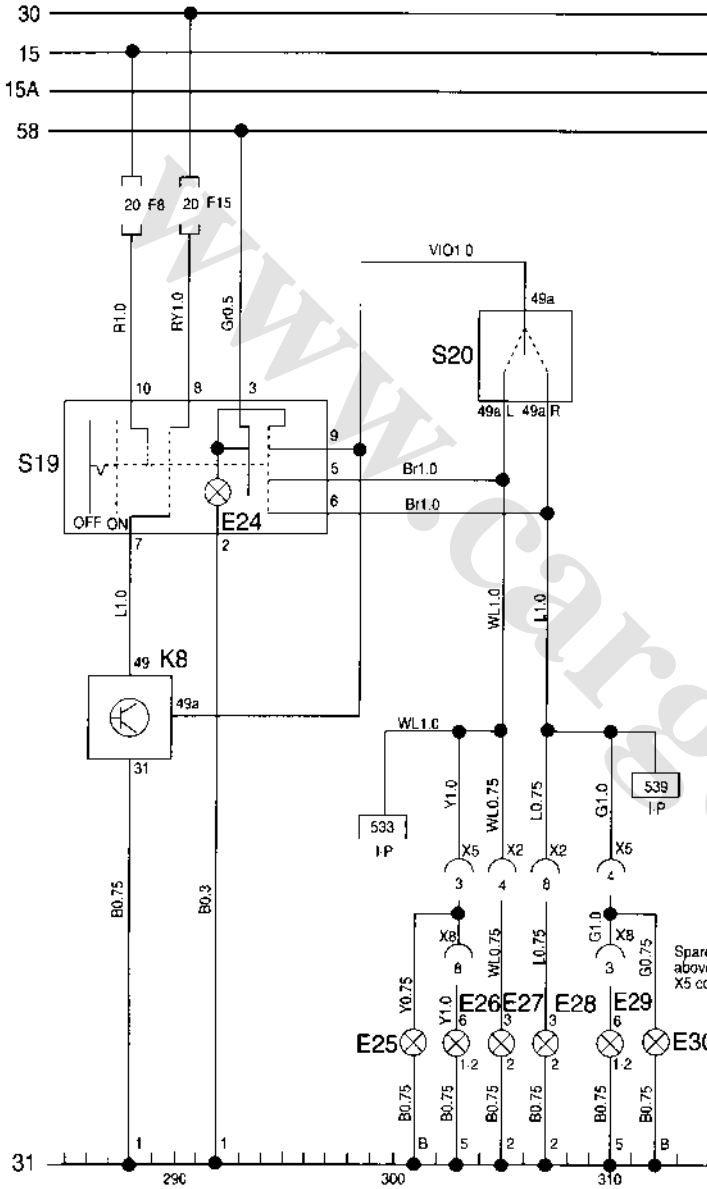

- E24 Illumination Lamp-Hazard Lamp Switch
This lamp has two functions.
 - Only Illumination Lamp function at the 1 step of the switch.
 - When Hazard Lamp Switch is "ON". It is on and off to notice that Hazard lamp is operating.
- S19 Hazard Lamp Switch
Each Hazard Lamp and Turn Signal Lamp have a fuse.
- S20 Turn Signal Lamp Switch
Turn Signal Lamp Switch is drawn individually on the wiring diagram but physically assembled within one body.
- K8 Turn Signal Lamp Relay
This relay receive power through Hazard lamp switch and supply current periodically. The current feed Hazard lamp Terminal 49a and Turn Signal Lamp Terminal 49a via Turn Signal lamp relay Terminal 49a. So that Each Turn signal Lamp is on and off.
 - [533], [539] analog I/P
This is connected to a turn signal lamp left and right.

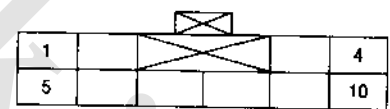

HAZARD LIGHT SWITCH



TURN SIGNAL LAMP(R)

TURN SIGNAL LAMP



TURN SIGNAL LAMP(R)



BLINICER UNIT

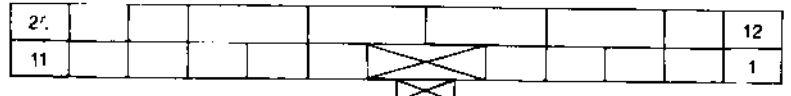

X5 CONNECTOR

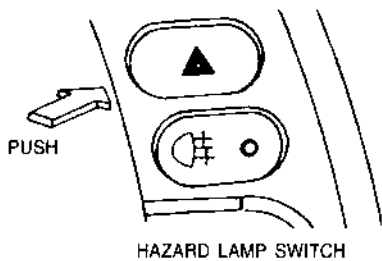
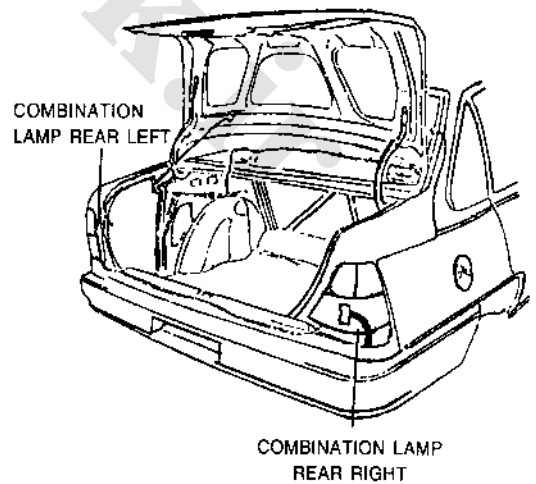
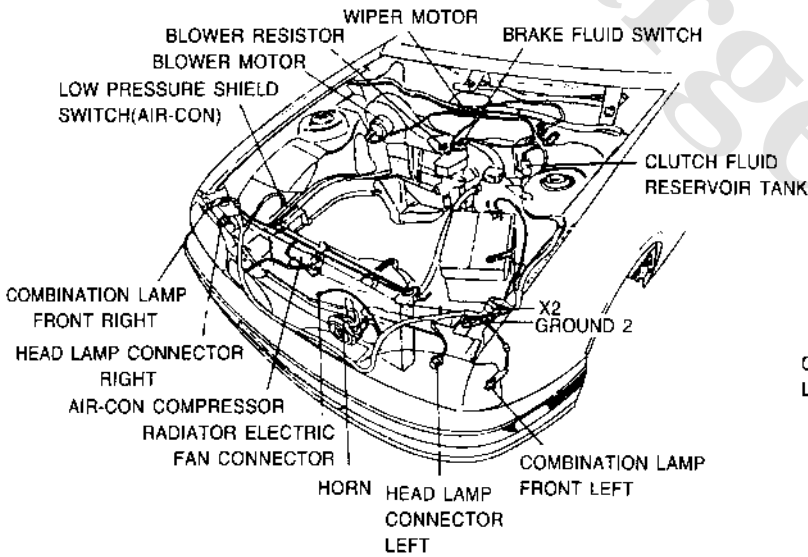
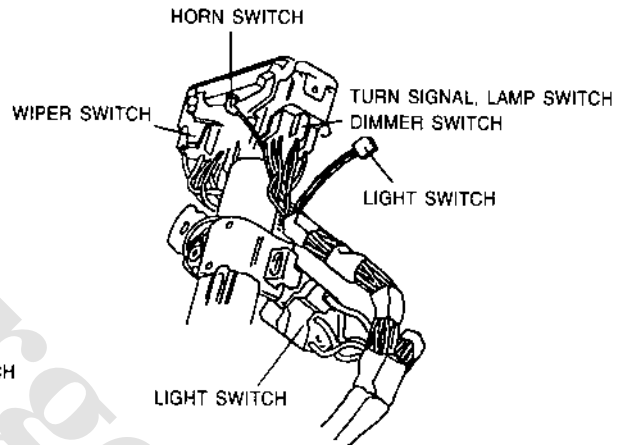
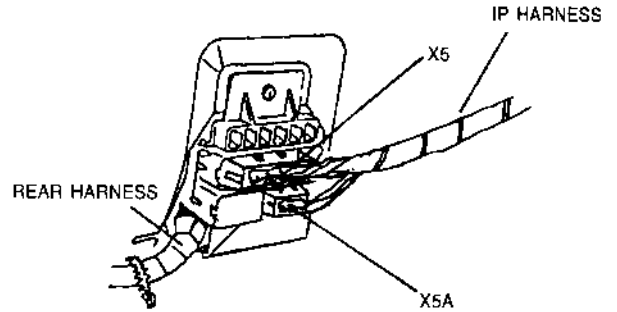
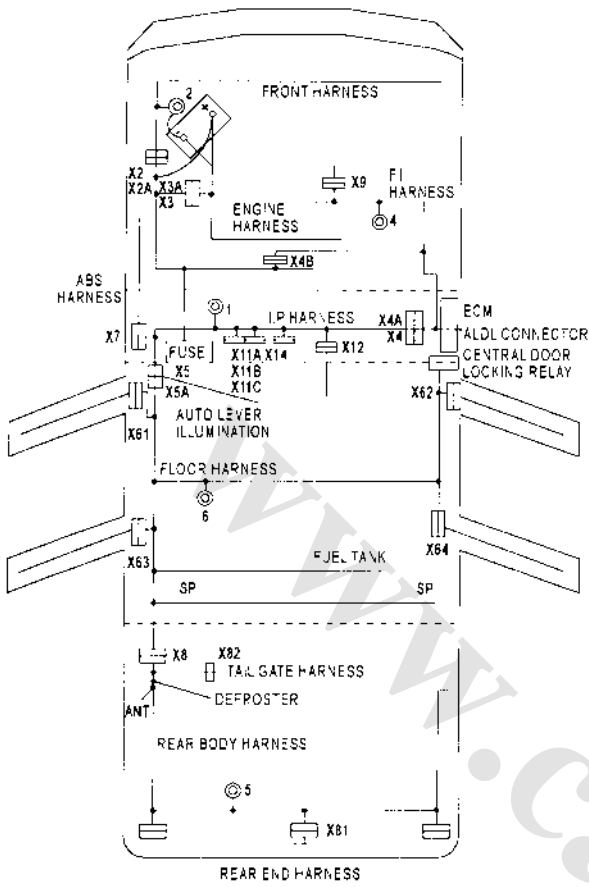

16) CHIME BELL, AUTO TRUNK, FUEL INLET SWITCH WIRING

K9 CHIME BELL
 S21 AUTO TRUNK SWITCH
 S22 FUEL INLET SWITCH
 S37 SEAT BELT SWITCH

Y5 AUTO TRUNK SOLENOID
 Y5-1 AUTO TRUNK SOLENOID(3-DOOR,5-DOOR)
 Y6 FUEL INLET SOLENOID

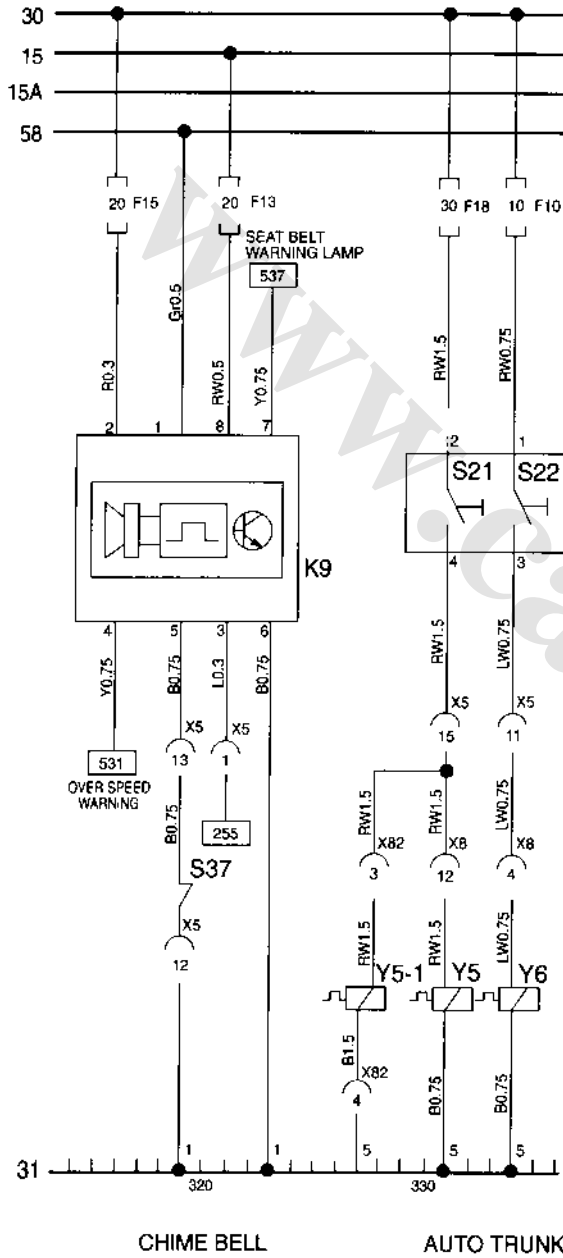

- S37 seat belt switch
This switch is "OFF", when fixing a seat belt.
- **S37** Analog I/P
• This is connected to a seat belt warning lamp in I/P.

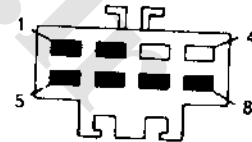

CHIME - WARNING RELAY CONNECTOR

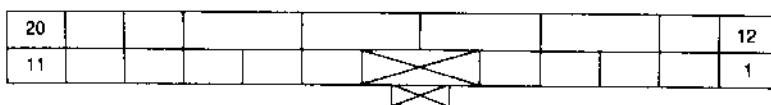

X5 CONNECTOR

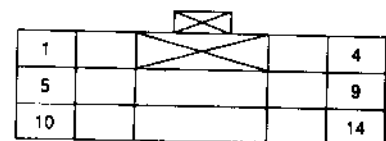

X8 CONNECTOR

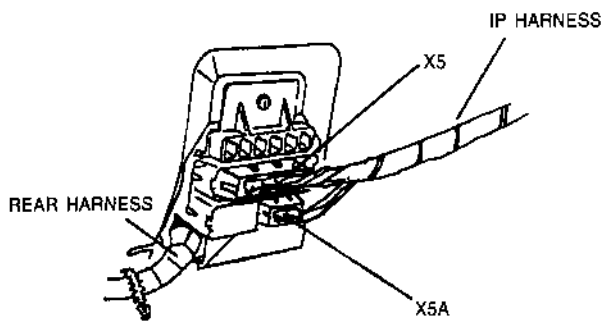
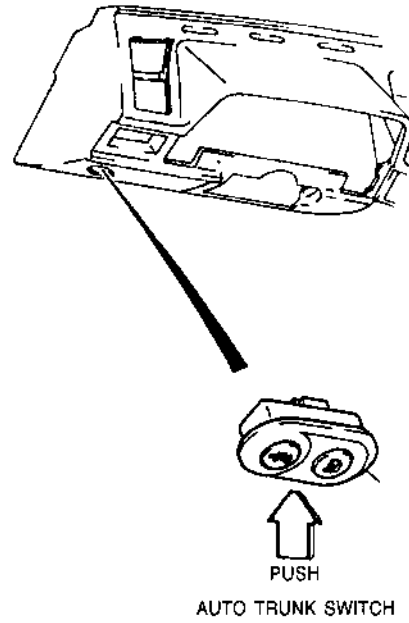
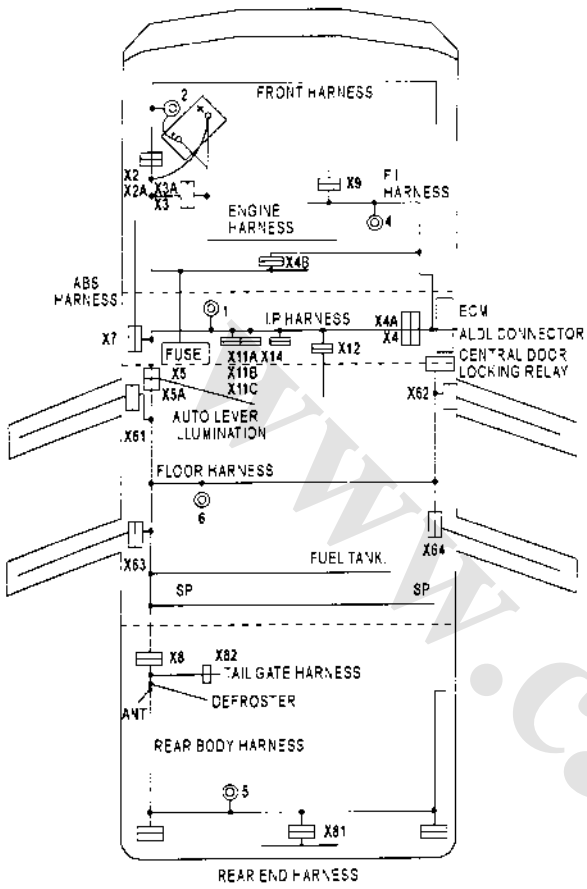

17) REAR WINDOW DEFROSTER WIRING

E31 ILLUMINATION – REAR WINDOW DEFROSTER SWITCH
 E32 OPERATION INDICATION-REAR WINDOW DEFROSTER SWITCH

K10 REAR WINDOW DEFROSTER TIME RELAY
 R11 REAR WINDOW DEFROSTER
 S23 REAR WINDOW DEFROSTER SWITCH

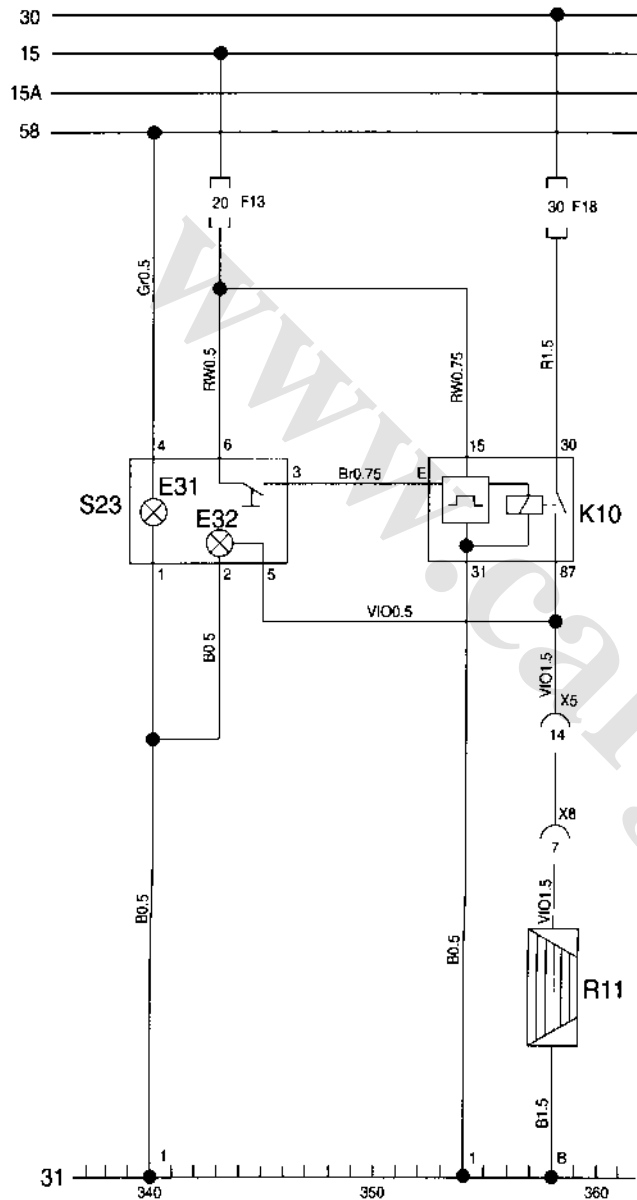

REAR WINDOW DEFROSTER

- S23 Rear window defroster switch
This is composed of E31 illumination lamp, defroster switch of one touch type, and a light emitting diode announcing that timer is operating.
- K10 Rear window defroster time relay
This has a 10 minute timer.
 - Defroster operation(ON)
When pushing this switch onetime, power is feeded to the terminal E of K10 relay and you can identify the defroster switch is operating and after the defroster time relay is operating for ten minute, it is off automatically a light emitting diode is on during a defroster is operating.
 - Releasing defroster operation (OFF)
When touching a defroster switch onetime, the K10 time relay operates. On touching again during operating, the defroster switch operation is released.

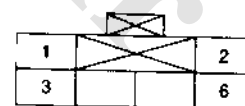

REAR WINDOW DEFROSTER TIME RELAY CONNECTOR

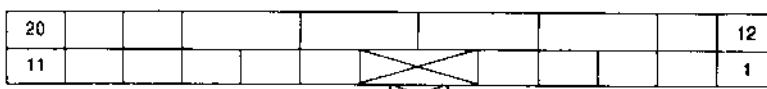

X5 CONNECTOR

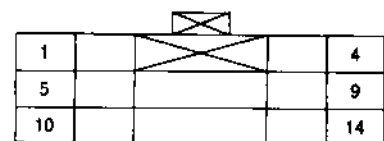

X8 CONNECTOR

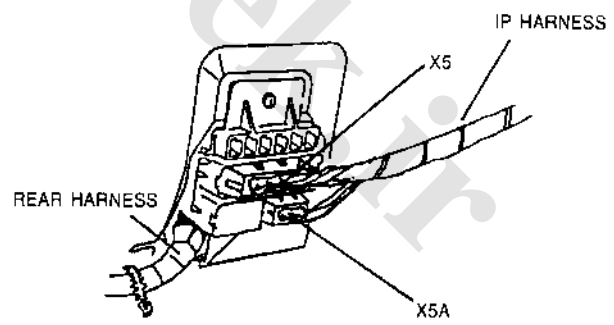
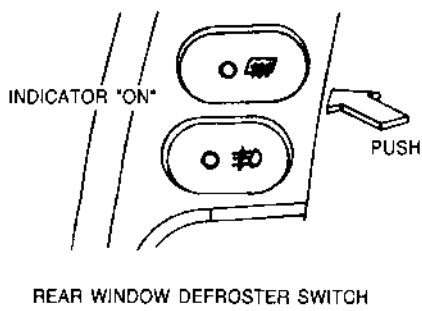
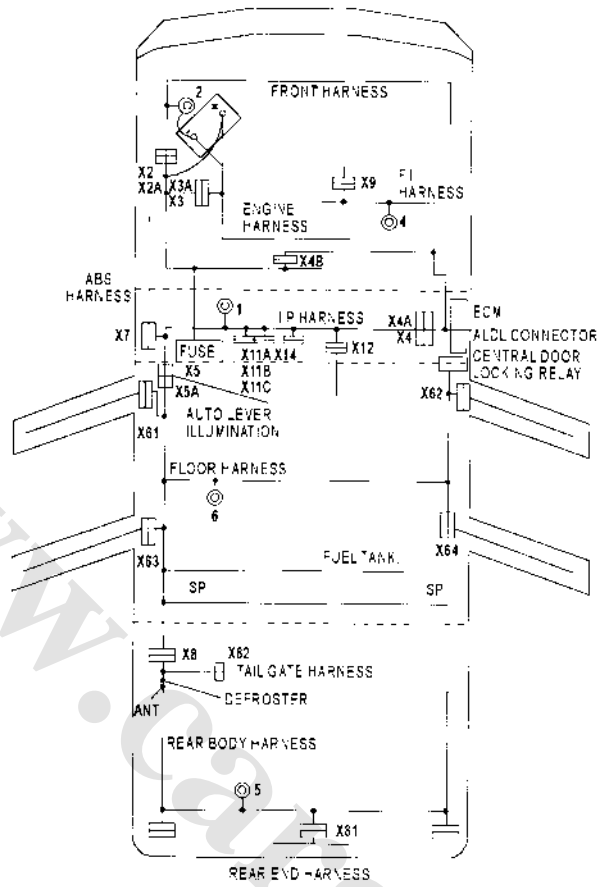

18) WIPER WIRING

- | | |
|--------------------------------------|--|
| K11 FRONT WIPER RELAY | M9 REAR WIPER MOTOR(3-DOOR,5-DOOR) |
| K12 WASHER PUMP RELAY(3-DOOR,5-DOOR) | M10 AUTO ANTENNA |
| K13 REAR WIPER RELAY(3-DOOR,5-DOOR) | R4 WIPER INTERVAL CONTROL SWITCH |
| M6 WASHER PUMP | S24 WASHER SWITCH |
| M7 WIPER MOTOR | S25 WIPER SWITCH |
| M8 WASHER MOTOR(3-DOOR,5-DOOR) | S25-1 REAR WIPER SWITCH(3-DOOR,5-DOOR) |

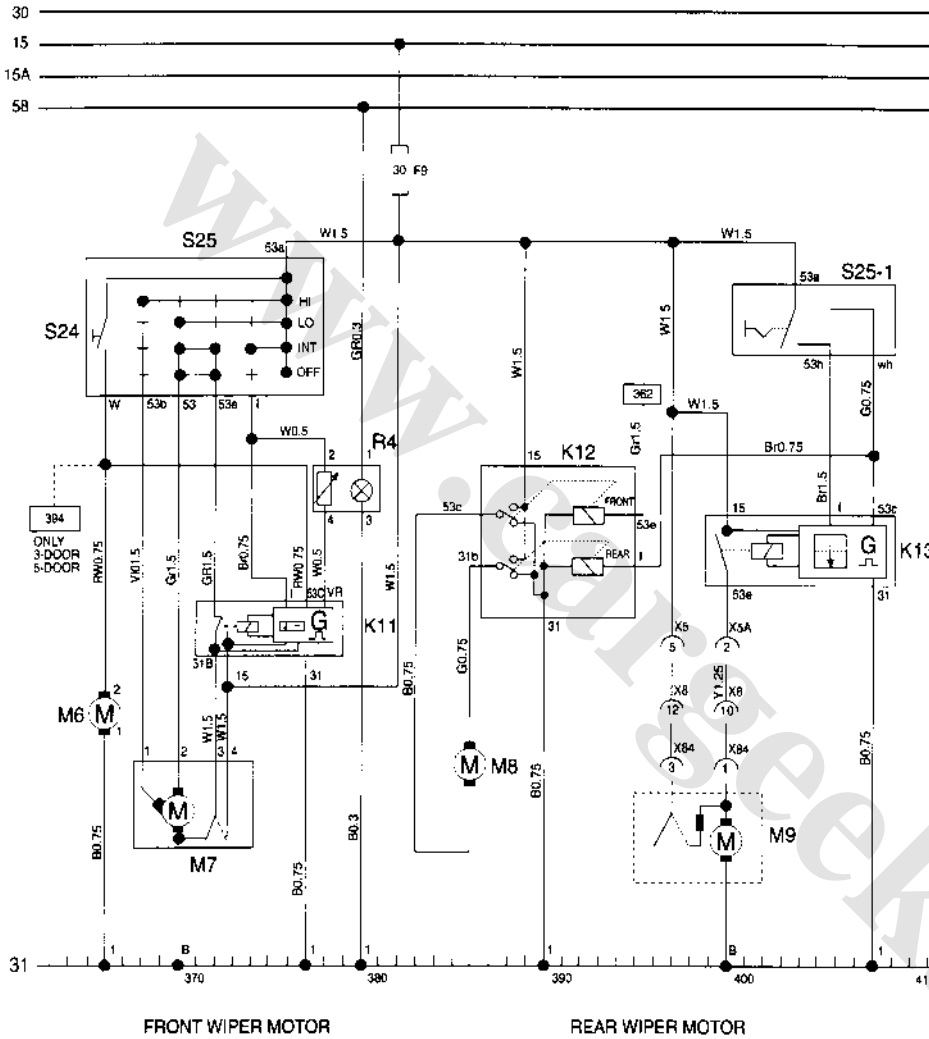

- S24 Wiper Switch
A wiper switch has two functions as follows;
 - OFF, INT, LO, HI function.
 - Operating a washer fluid pump motor terminal numbers indexed on the switch.
- K11 Wiper Relay
A wiper relay has two major functions.
 - When a switch is at the INT position, this wiper relay operates periodically with 4 to 21 seconds interval according to manipulate the interval control switch.
 - When operating a washer fluid switch, a washer fluid pump motor operates and power is supplied to terminal 53C of K11 wiper relay.
A wiper relay operates for about 4 seconds from the moment when a washer fluid switch is OFF.
- S25 wiper switch, s25-1 rear wiper switch
A wiper switch and A rear wiper switch are display respectively on the wiring diagram.
But these are assembled physically in a device

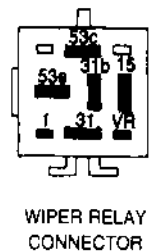
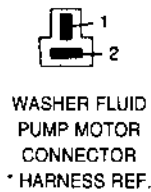
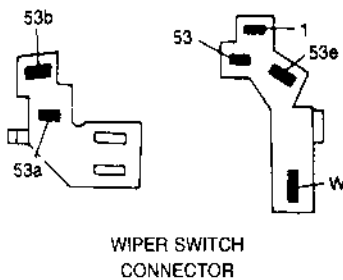

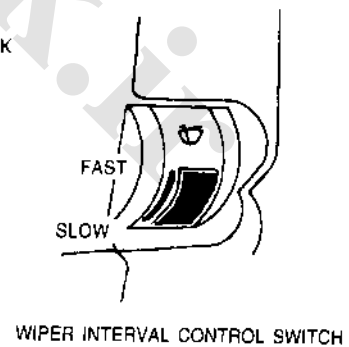
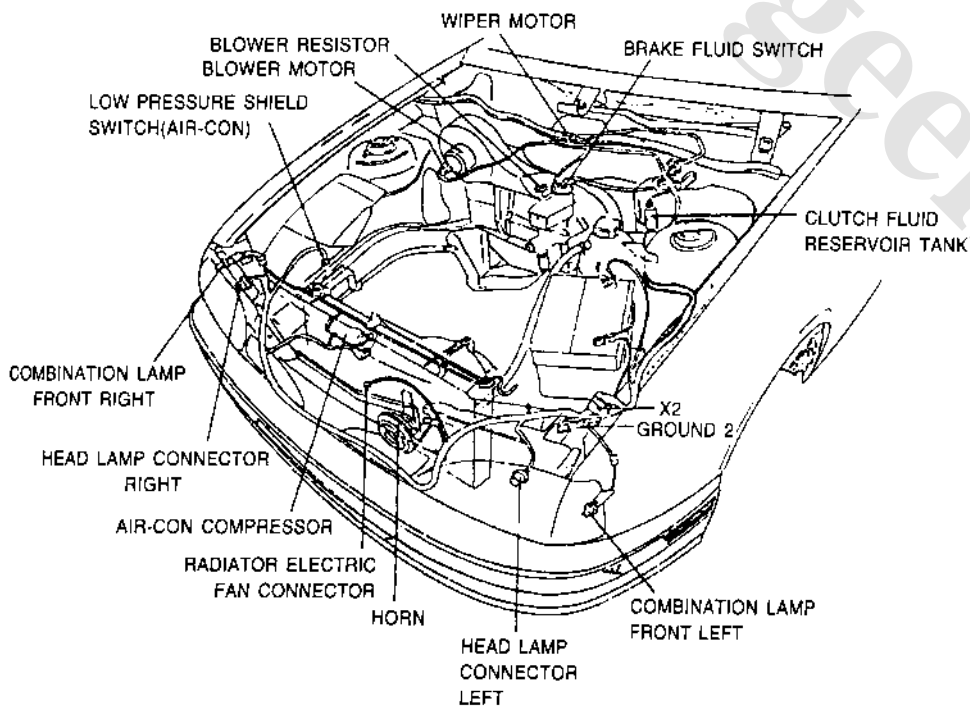
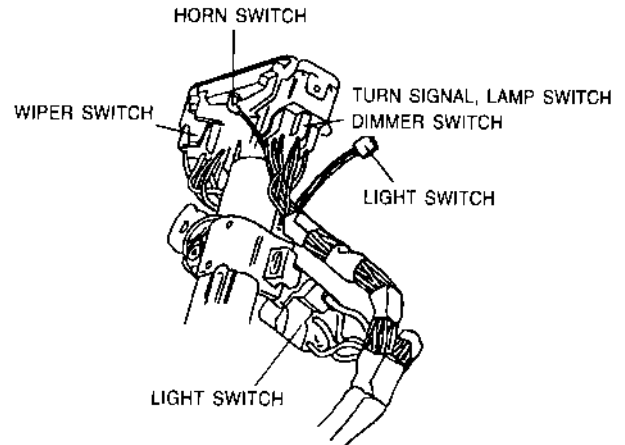
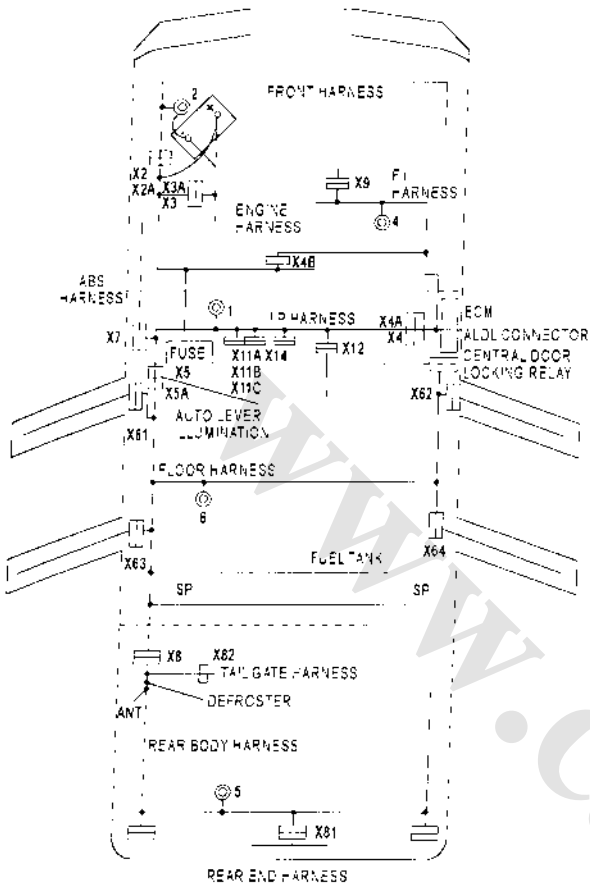

19) CASSETTE RADIO WIRING

H3 SPEAKER-F.L
H4 SPEAKER-R.L
H5 SPEAKER-F.R

H6 SPEAKER-R.R
H7 CASSETTE RADIO

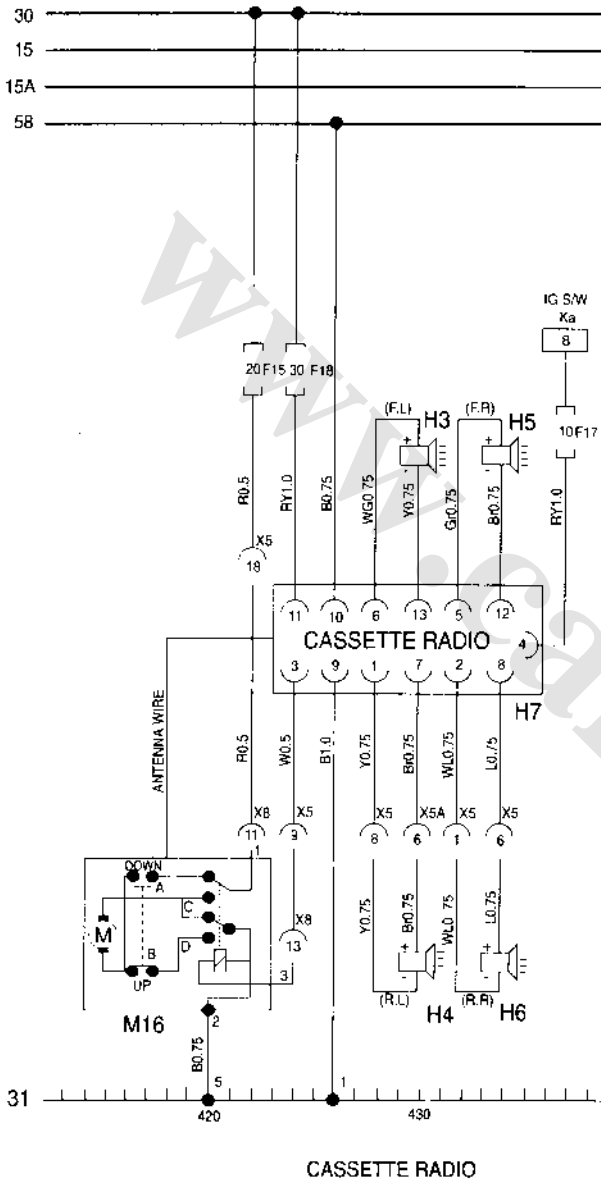

- M16 Auto Antenna
 - When a radio is "ON";
12V power is supplied to terminal 3 of cassette radio and the inner relay of an auto antenna operates. Because the cross of C is connected to "+" and the cross of D is connected to "-", the antenna motor circulates. When an antenna reaches at the end position, the cross of "A" is connected and the cross of "B" is disconnected. At this time, the antenna motor stops and keeps the current status on.
 - When a radio is "OFF";
The inner relay does not operate because power is not feeded from terminal 3 of H6 radio. At this time, the cross of C is connected to "-", and the cross of A is connected to "+" so that the antenna motor operates and the antenna is down. When the antenna arrives at the bottom, the cross of A is disconnected, and the cross of B is connected to so that the antenna motor stops.

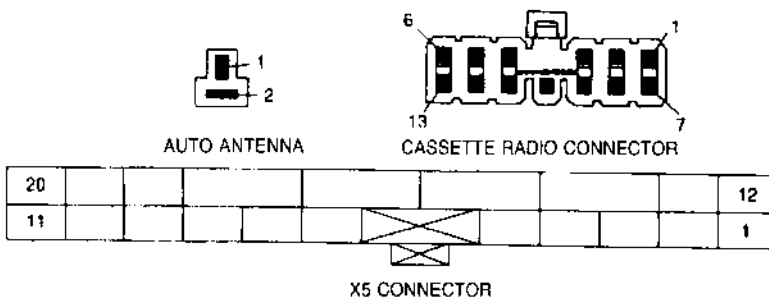

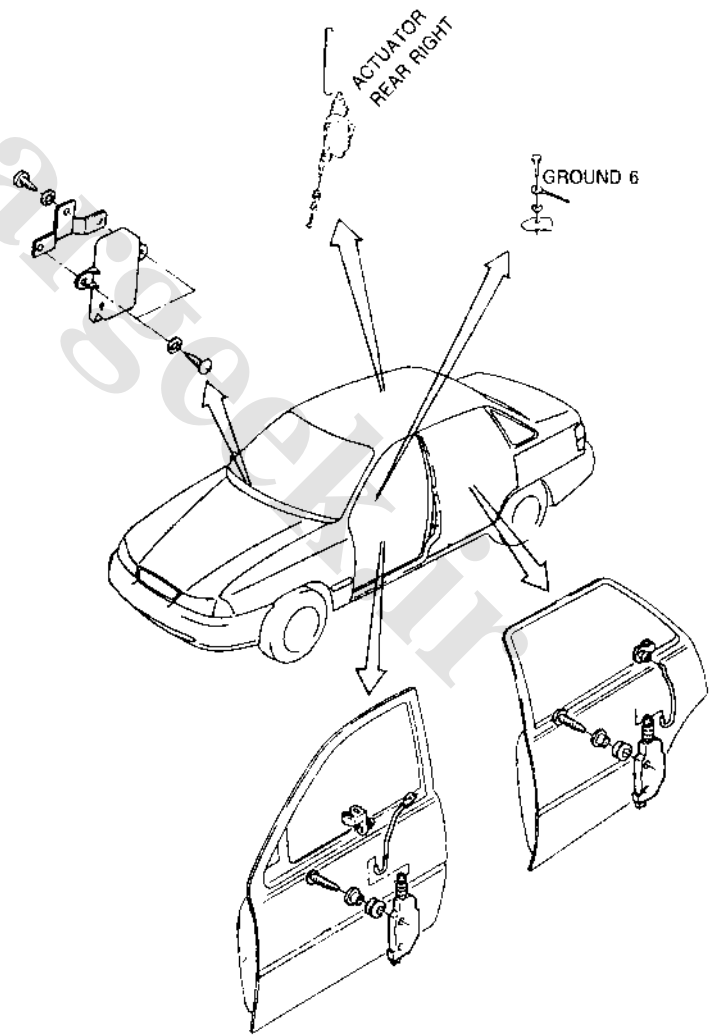
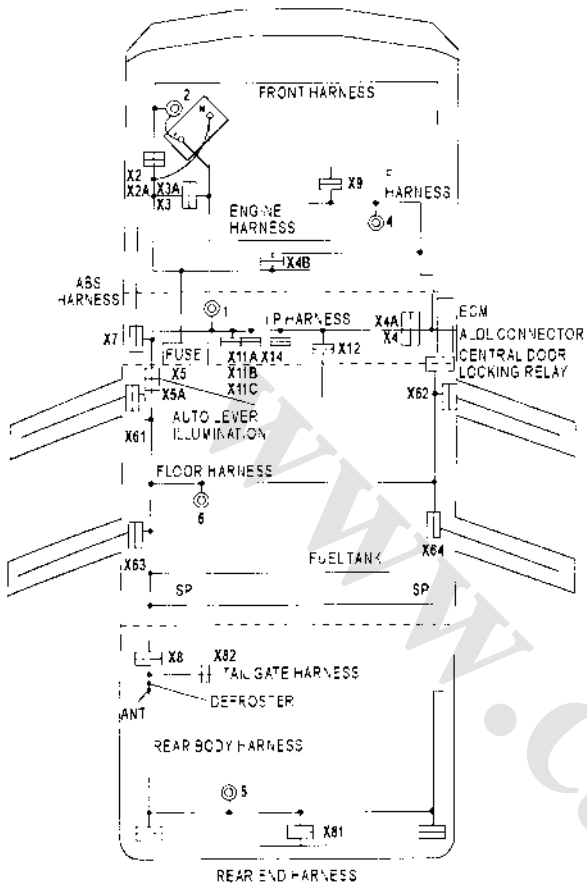

20) POWER WINDOW WIRING(LHD, RHD)

- M10 POWER WINDOW MOTOR(F.L)-LHD
- M12 POWER WINDOW MOTOR(F.R)-LHD
- M13 POWER WINDOW MOTOR(R.L)-LHD
- M14 POWER WINDOW MOTOR(R.R)-LHD
- M15 POWER WINDOW MOTOR(F.R)-RHD
- M16 POWER WINDOW MOTOR(F.L)-RHD
- M17 POWER WINDOW MOTOR(R.R)-RHD
- M18 POWER WINDOW MOTOR(R.L)-RHD

- S26 POWER WINDOW MAIN SWITCH-LHD
- S26-1 POWER WINDOW MAIN SWITCH-RHD
- S37 POWER WINDOW SWITCH(F.R)-LHD
- S38 POWER WINDOW SWITCH(R.L)-LHD
- S39 POWER WINDOW SWITCH(R.R)-LHD
- S40 POWER WINDOW SWITCH(F.L)-RHD
- S41 POWER WINDOW SWITCH(F.L)-RHD
- S42 POWER WINDOW SWITCH(R.L)-RHD

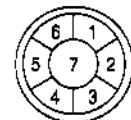
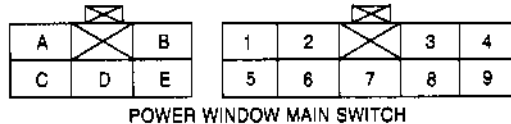
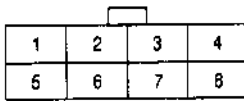
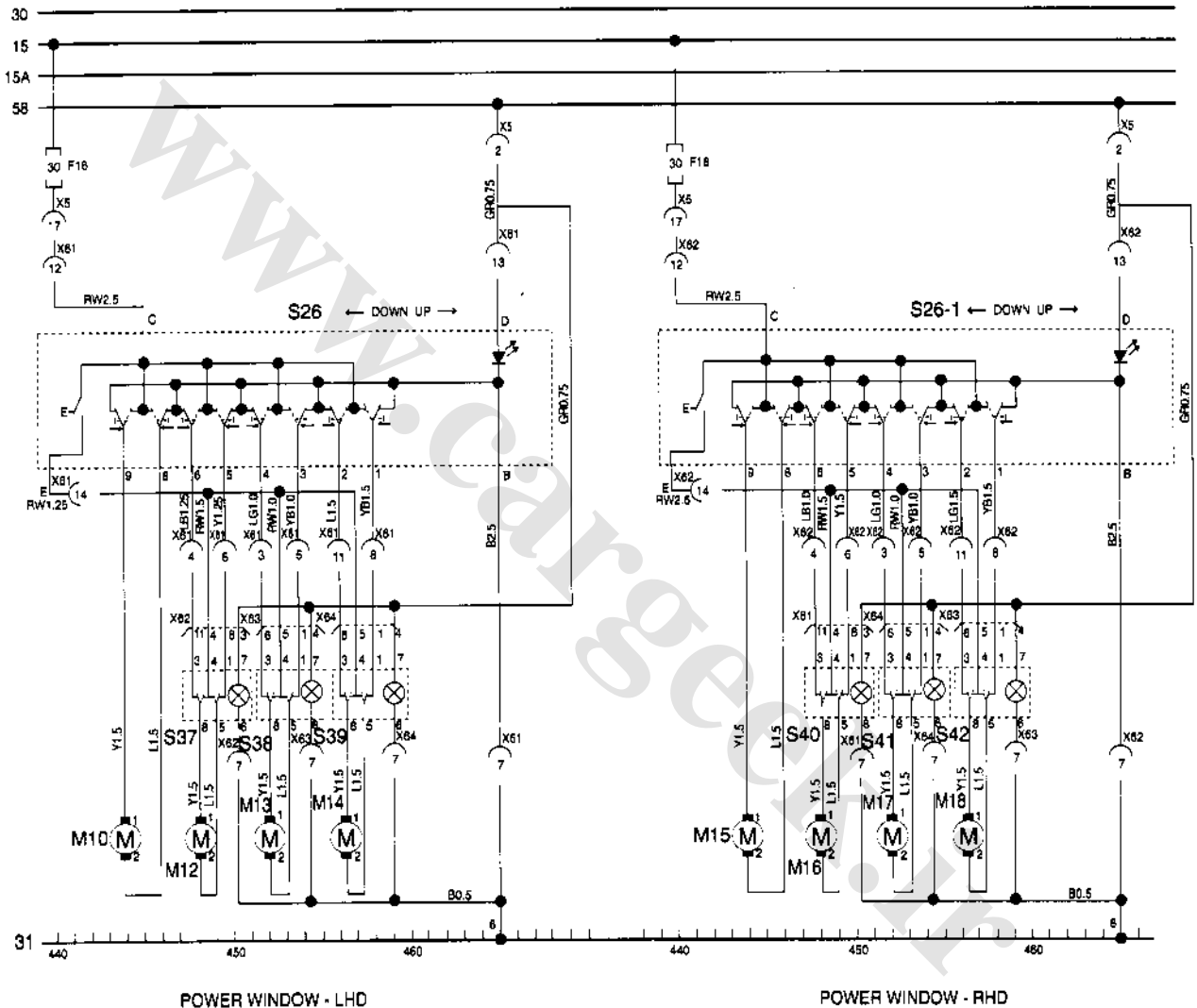

X83, 84 CONNECTOR

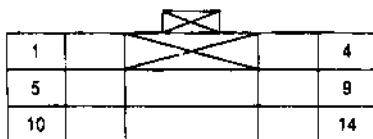

X61, 62 CONNECTOR

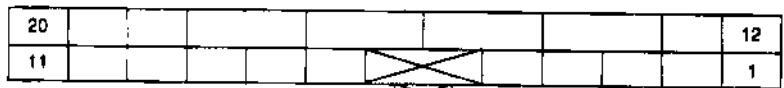

X5 CONNECTOR

- Whenever the power window main switch(S26, S26-1) is not operated, all contact points is connected to the ground. If the power window S/W of the front driver seat is down, the terminal 8 is connected to B+(C) and 9 is not operated so that the ground terminal.
- The main power is ON/OFF by the rear power window lock S/W so that it is impossible to operate the power windows a individually at the co-driver seat or the rear seats. (For example: when a children is in the car, the main S/W is OFF so that the rear power window S/W is not operated.)

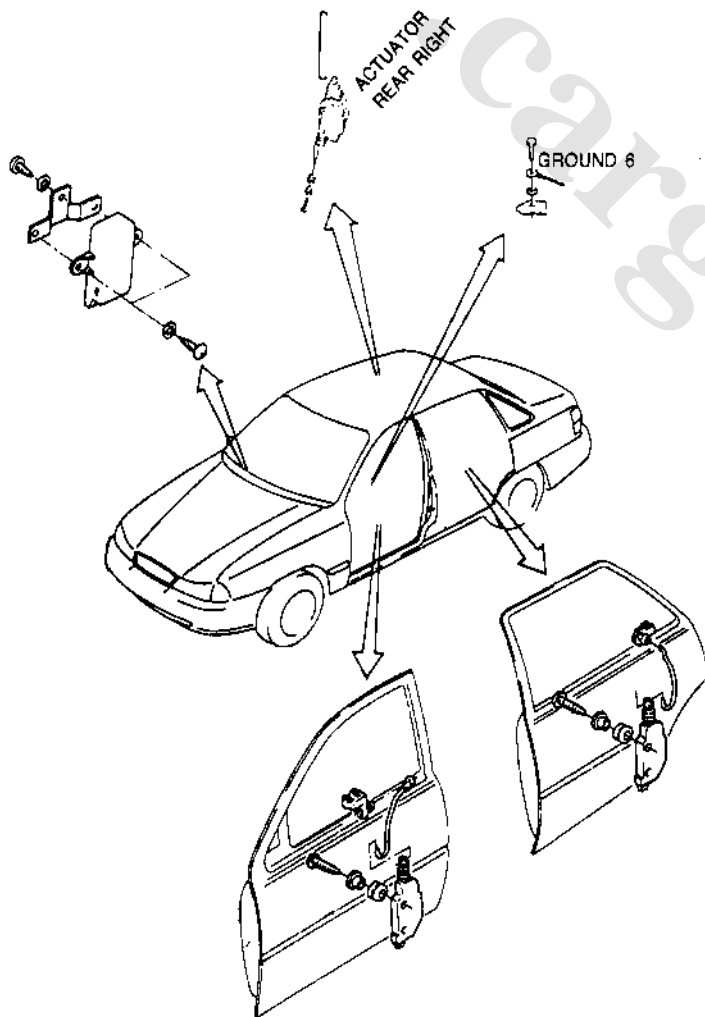
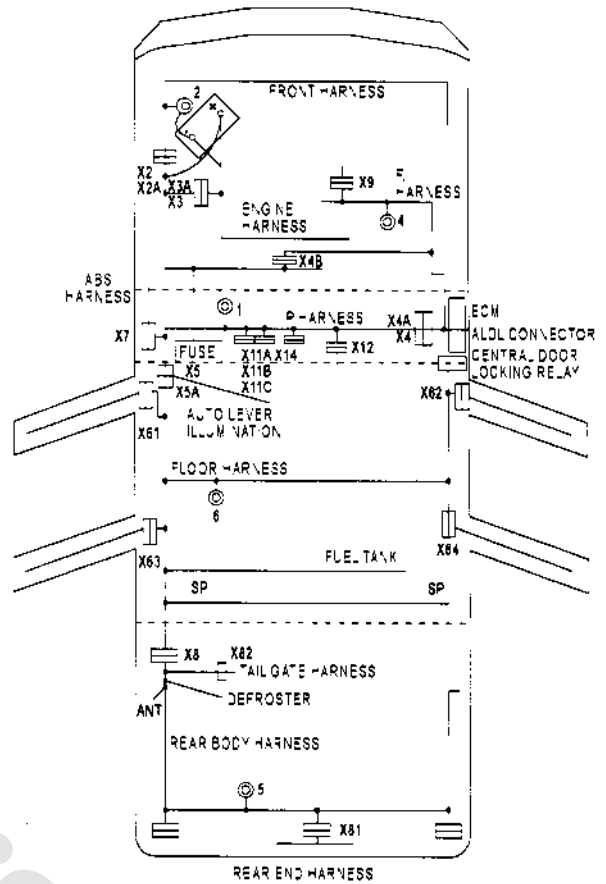

21) CENTRAL DOOR LOCKING SYSTEM WIRING (LHD, RHD)

- K14 CENTRAL DOOR LOCKING RELAY
- K14-1 CENTRAL DOOR LOCKING RELAY(RHD)
- M19 ACTUATOR, FRONT RIGHT-LHD
- M20 ACTUATOR, REAR RIGHT-LHD
- M21 ACTUATOR, REAR LEFT-LHD
- M22 ACTUATOR, FRONT LEFT-RHD
- M23 ACTUATOR, REAR RIGHT-RHD
- M24 ACTUATOR, REAR LEFT-RHD
- S27 CENTRAL DOOR LOCKING SWITCH-LHD
- S27-1 CENTRAL DOOR LOCKING SWITCH-RHD

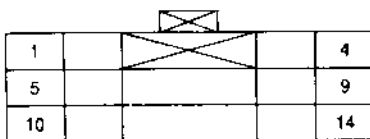
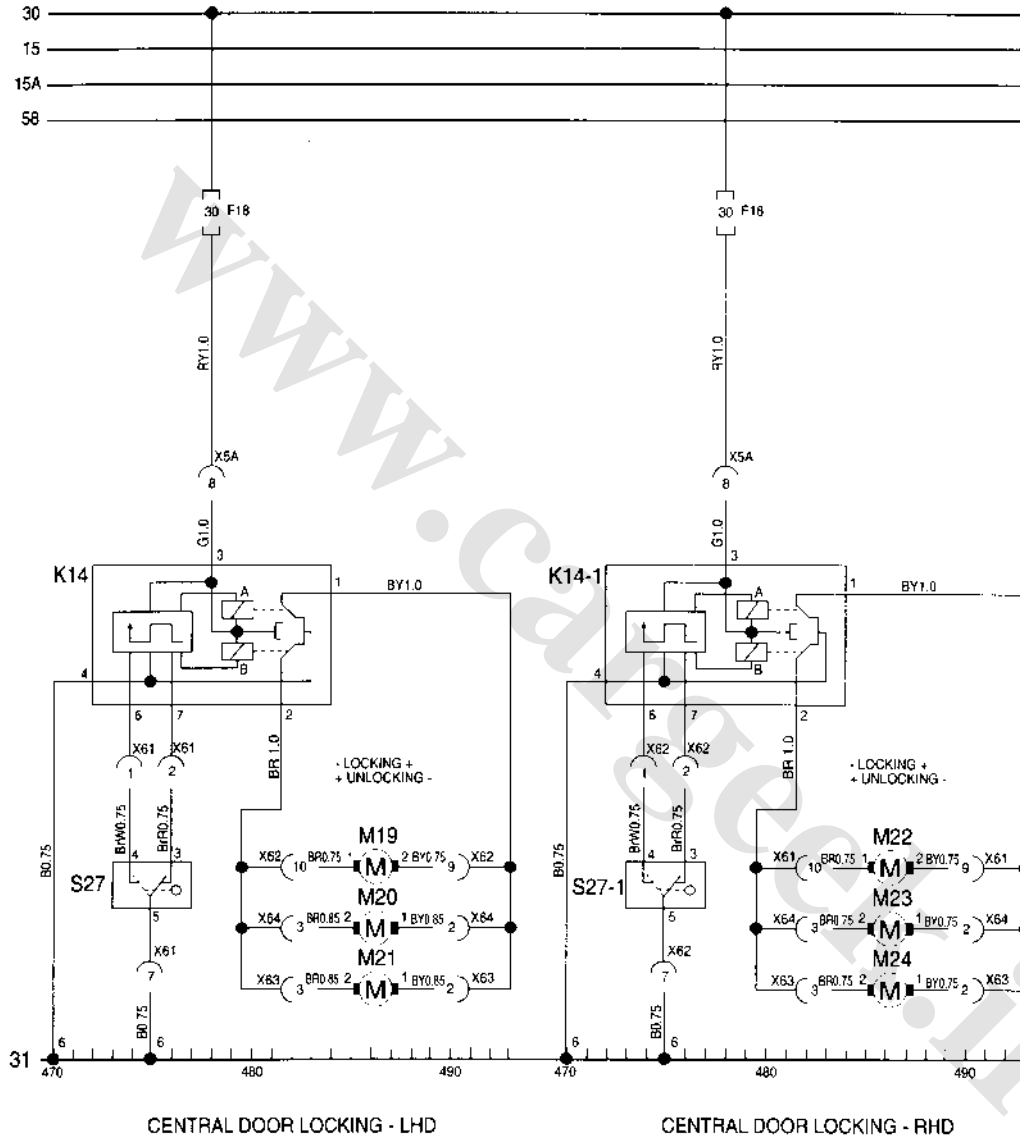

X61, 62 CONNECTOR

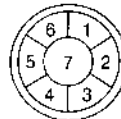

X63, 64 CONNECTOR

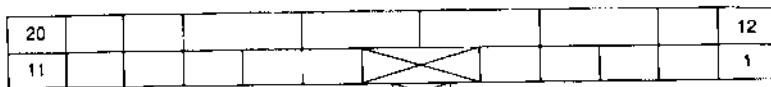

X5 CONNECTOR



CENTRAL DOOR LOCKING SWITCH CONNECTOR



ACTUATOR CONNECTOR

- K14, K14-1 central door locking relay
- A central door locking relay operates for 0.7 second when opening or locking.
- No Operating;
 - When the relay is not operating, the terminal 1 and terminal 7 are connected to terminal 4 in the relay.
 - When Locking;
 - When S27, S27-1 central door locking switch is set to the locking position, terminal 7 is connected to the ground and "A" relay in the relay is operating for 0.7 second.
 - At this time, terminal 1 is "+" and terminal 2 is "-" so that three actuators operates contemporary to the locking direction.
 - On Opening;
 - When S27, S27-1 is set to the opening position, terminal 6 is connected to the ground and the inner "B" relay of the relay is operating for 0.7 second.
 - The terminal 1 is "-" and the terminal 2 is "+" so that three actuators operates contemporary to the opening direction.

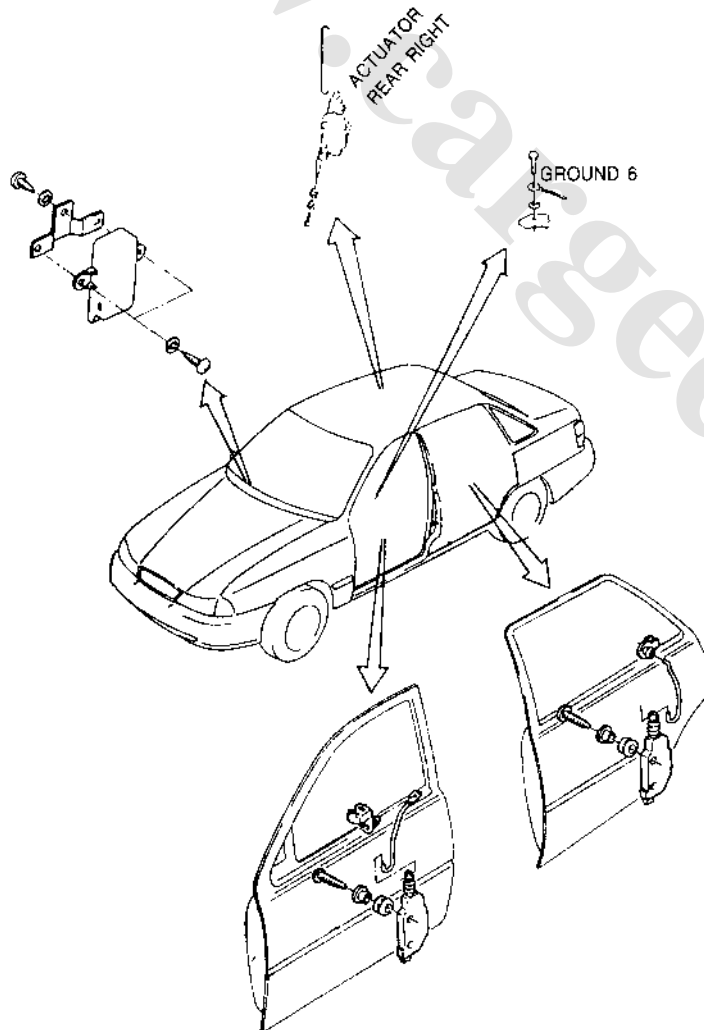
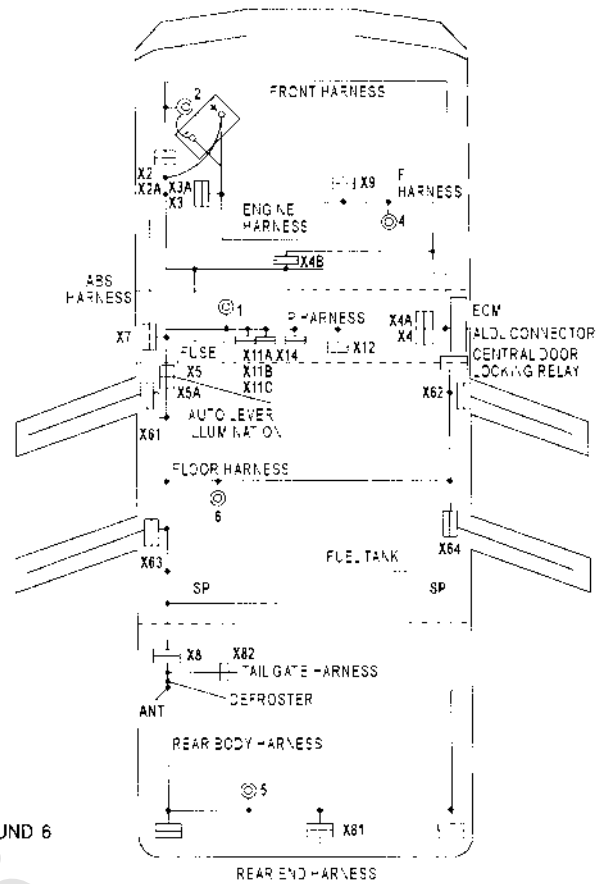

NEXIA, CIELO, RACER II

22) I-P WIRING

- E33 POWER WARNING LAMP
- E34 AIR BAG WARNING LAMP
- E35 ABS WARNING LAMP
- E36 FUEL WARNING LAMP
- E37 OIL WARNING LAMP
- E38 "SES" INDICATOR
- E39 PARKING BRAKE FLUID WARNING LAMP
- E40 HIGH BEAM INDICATOR

- E41 CHARGING WARNING LAMP
- E42 WASHER FLUID WARNING LAMP
- E43 TURN SIGNAL LAMP - LH
- E44 DOOR OPEN WARNING LAMP
- E45 SEAT BELT WARNING LAMP
- E46 TURN SIGNAL - RH
- E47 I-P ILLUMINATION LAMP
- H8 I-P

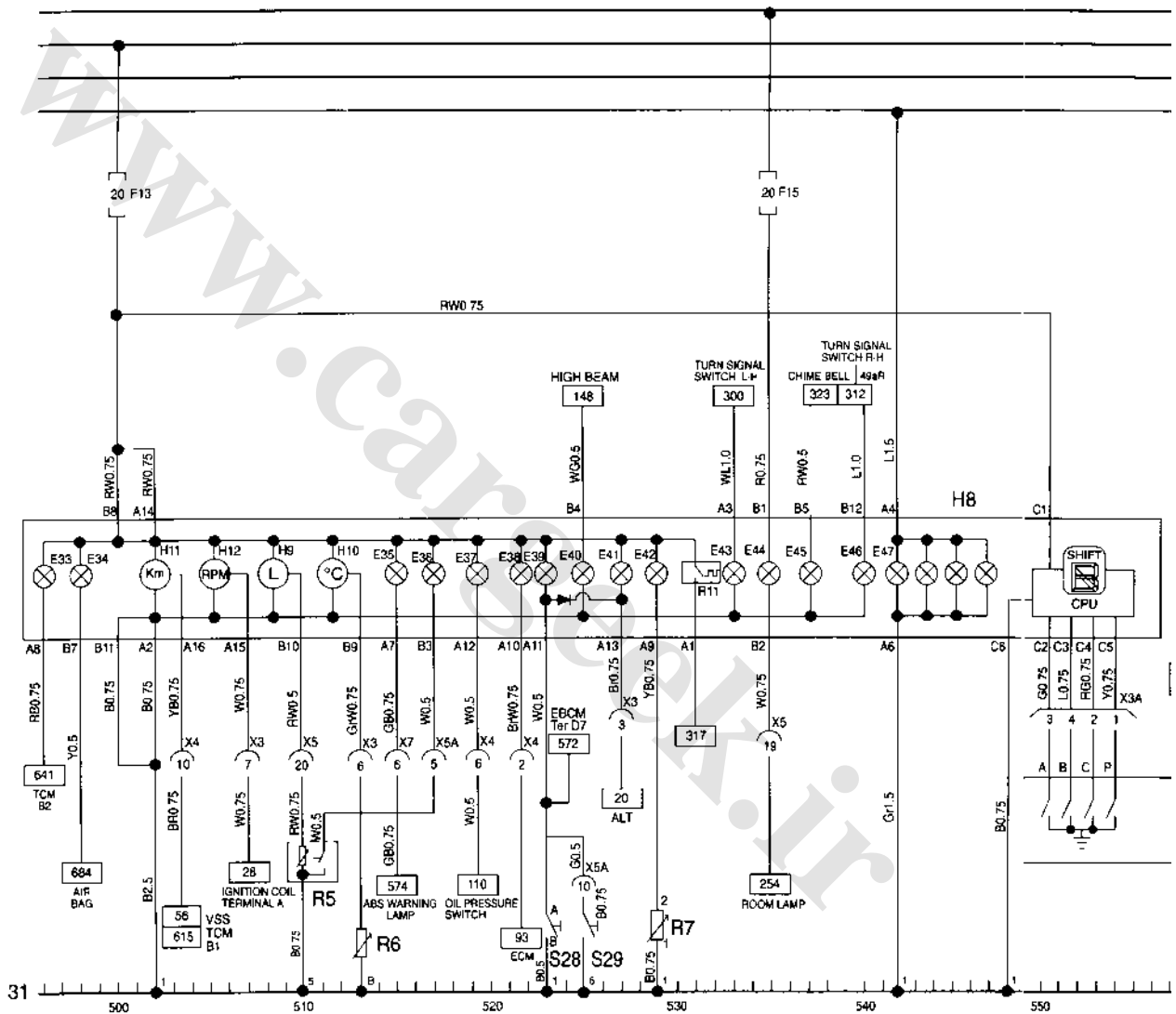

INSTRUMENT PANEL



BRAKE FLUID SWITCH CONNECTOR

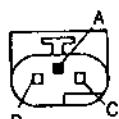

OIL PRESSURE SWITCH CONNECTOR

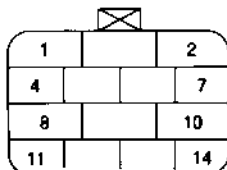

X3 CONNECTOR

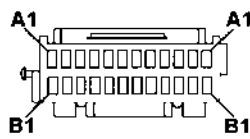

ECM CONNECTOR

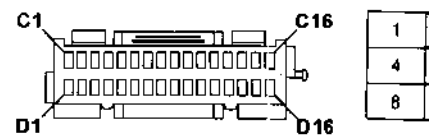

- LAMP
 - ING LAMP
 - LH
 - LAMP
 - LAMP
 - P
- H9 FUEL LEVEL GAUGE
 - H10 TEMPERATURE GAUGE
 - H11 SPEEDO METER
 - H12 TACHO METER
 - R5 FUEL TANK UNIT
 - R6 COOLANT TEMPERATURE UNIT
 - R7 WASHER FLUID LEVER SWITCH
 - S43 NSBU SWITCH(4 AT)

- S28 BRAKE FLUID LEVEL SWITCH
- S29 PARKING BRAKE SWITCH
- R11 OVER SPEED WARNING SWITCH

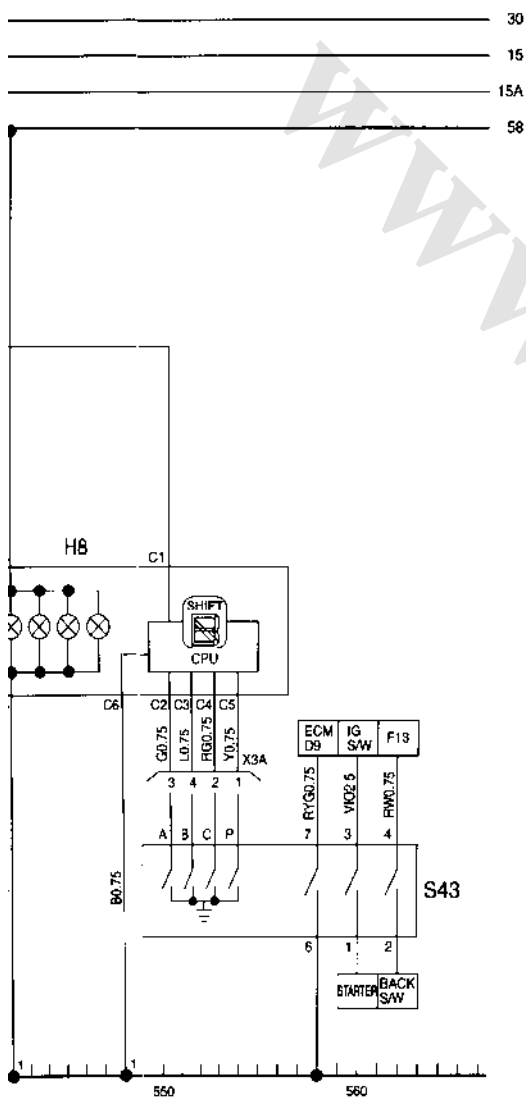

- E38 "Engine Service Soon" indicator
An "Engine Service Soon" indicator is ON when an ignition switch is "ON" or ECM has any trouble.(K1 ECM controls terminal) to be connected to a ground and when terminal A and B of ALDL connector is jumped with wire and an ignition switch is "ON" an engine control indicator is ON and OFF to indicate a fault code.
- R5 Fuel Sensor
A fuel level sensor and a fuel warning lamp switch is installed in the fuel tank and these are assembled in a housing.
 - Fuel level sensor resistance
 - 1/4 degree of fuel level: 148-192ohms
 - 1/2 degree of fuel level: 97-127ohms
 - 3/4 degree of fuel level: 66-86ohms
 - Fuel warning lamp
After a fuel warning lamp is "ON", a driver can drive up to about 50km.
- R6 Temperature Sensor
Resistance
 - 50°C: 226-340ohms
 - 70°C: 123-185ohms
 - 80°C: 92-138ohms
 - 100°C: 53-80ohms
 - 110°C: 42-62ohms
 - 120°C: 32-82ohms
- 20 ALT(Alternator) L Terminal
When an ignition switch is ON, the current is supplied as below and a battery charging warning lamp is ON:
F13 → Battery charging warning lamp → ALT L Terminal → Rotary coil Ground.
- 28 Ignition Coil "-"
An Ignition Coil "-" Terminal detects engine RPM
- 148 F4 High Beam Lamp
A Fuse 4 is connected to a high beam lamp(right)
- 300 L
Turn signal lamp left
- 312 R
Turn signal lamp right

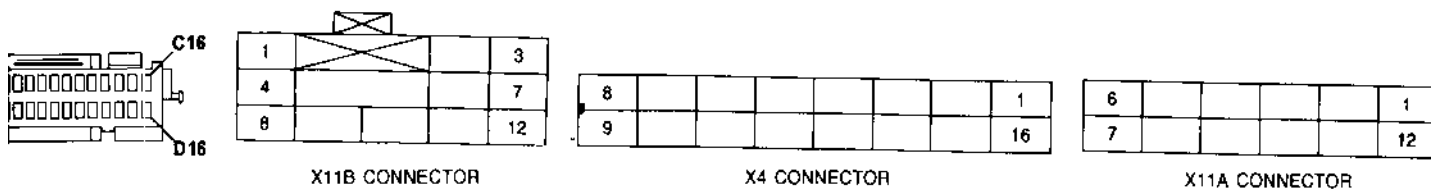

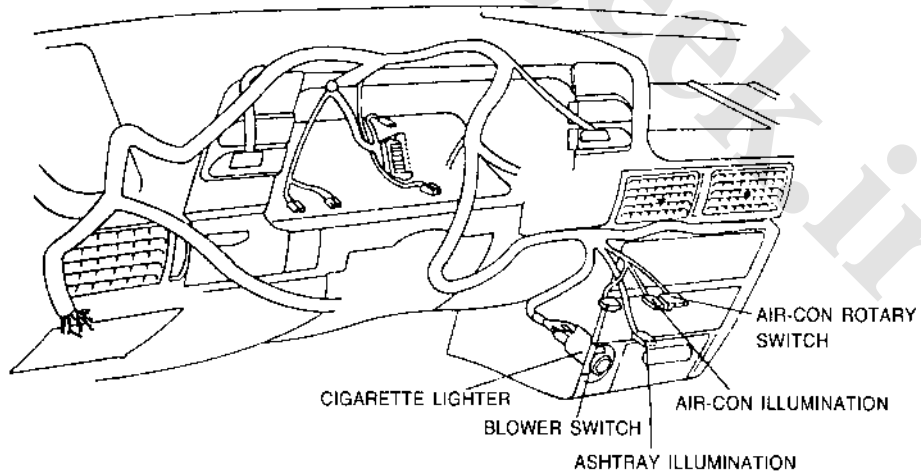
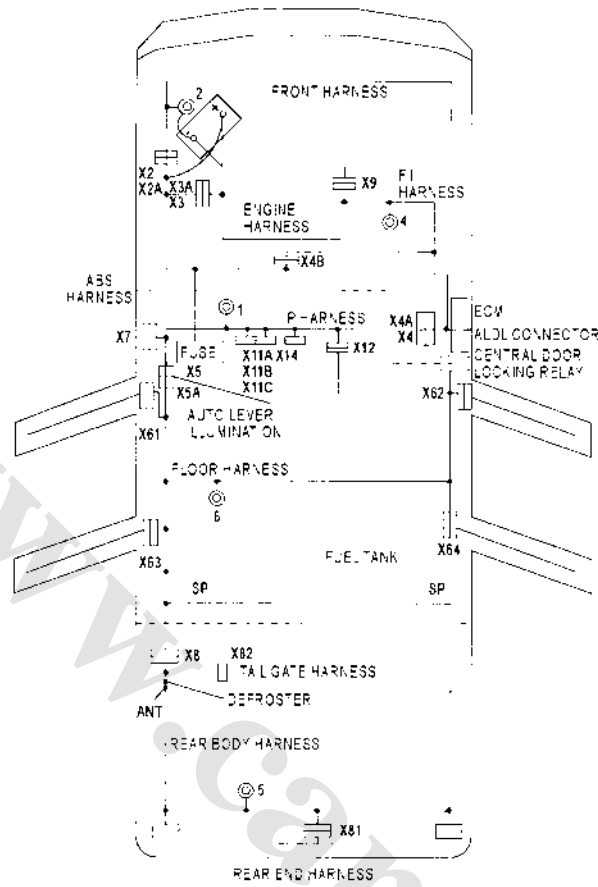

23) ABS(OPTION)

- K15 ABS WARNING LAMP MODULE
- K16 ABS RELAY
- K17 ABS - ECM(EBCM)
- M25 ABS MOTOR(F.L)
- M26 ABS MOTOR(F.R)
- M27 ABS MOTOR(R.R)

- P7 WHEEL SPEED SENSOR(F.L)
- P8 WHEEL SPEED SENSOR(F.R)
- P9 WHEEL SPEED SENSOR(R.L)
- P10 WHEEL SPEED SENSOR(R.R)
- S28 BRAKE FLUID LEVEL SWITCH
- S29 PARKING BRAKE SWITCH

- Y7 SOLENOID(F.R)
- Y8 SOLENOID(F.L)

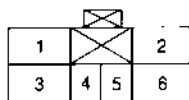
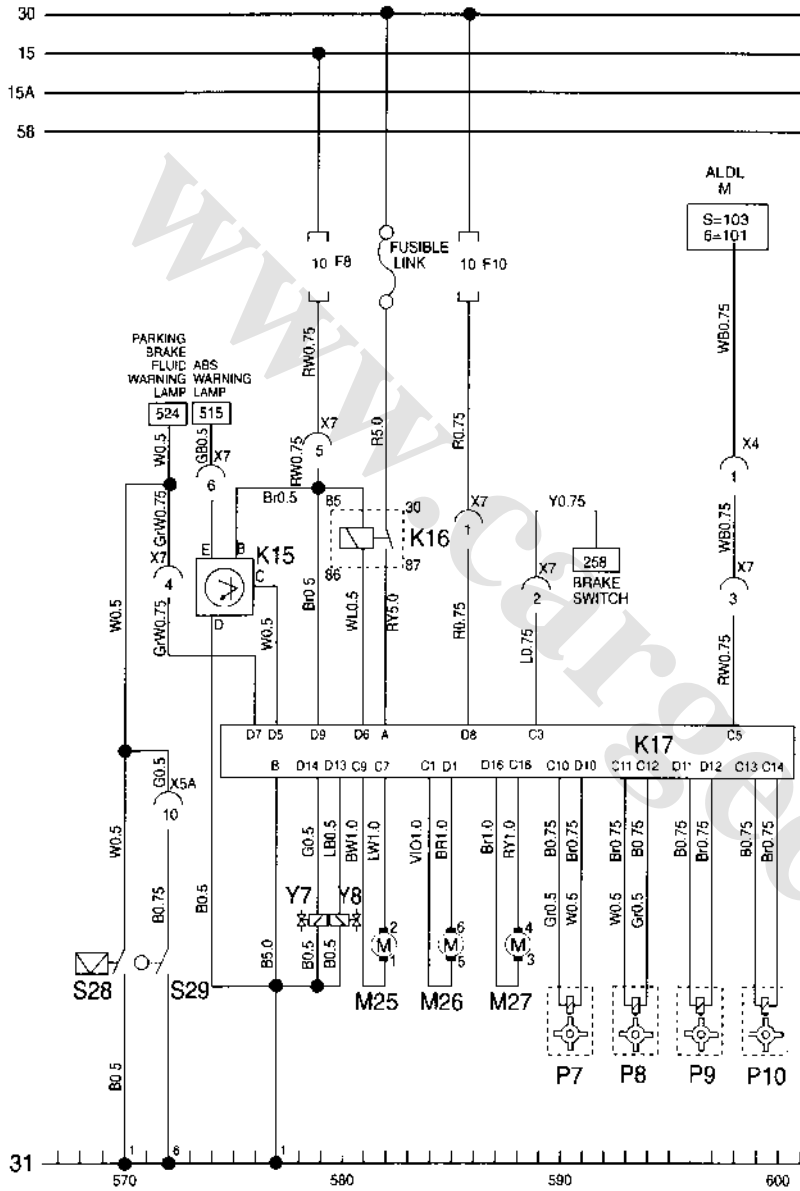

X7 CONNECTOR

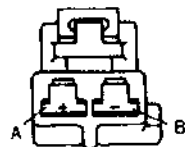

ABS-ECU POWER END GROUND
(ABS HARNESS REF.)

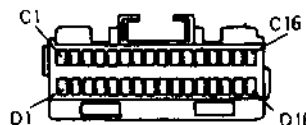

ABS-ECU
(ABS HARNESS REF.)

24) TCM(OPTION)

K18 TRANSAXLE CONTROL MODULE(TCM)
 P1 VEHICLE SPEED SENSOR(VSS)

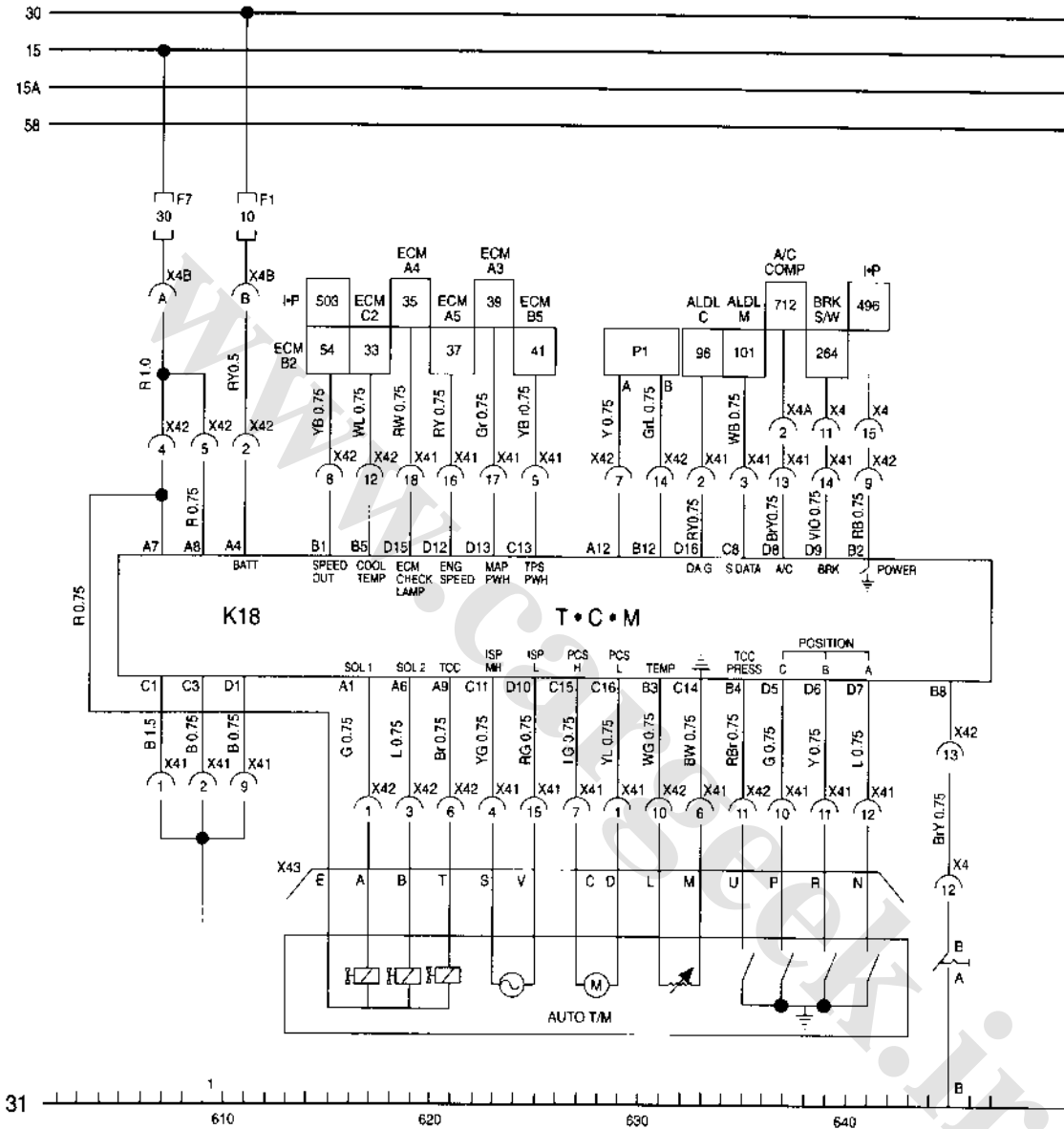

T • C • M

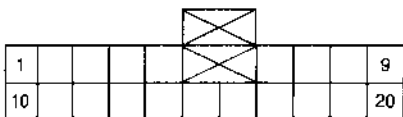

X41 CONNECTOR(4-SP A/T)

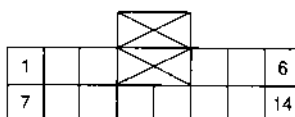

X42 CONNECTOR(4-SP A/T)

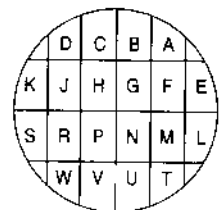

X43 CONNECTOR(4-SP A/T)

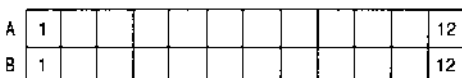

A 1 12



B 1 16

TCM CONNECTOR(4-SP A/T)

25) IMMOBILIZER, AIR BAG(OPTION)

K19 IMMOBILIZER CONTROL UNIT
K20 AIR BAG CONTROL UNIT

R8 TRANSPONDER DETECTION COIL
R9 CONTACT COIL
S9-1 HORN SWITCH(AIR BAG TYPE)

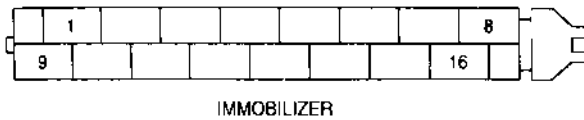
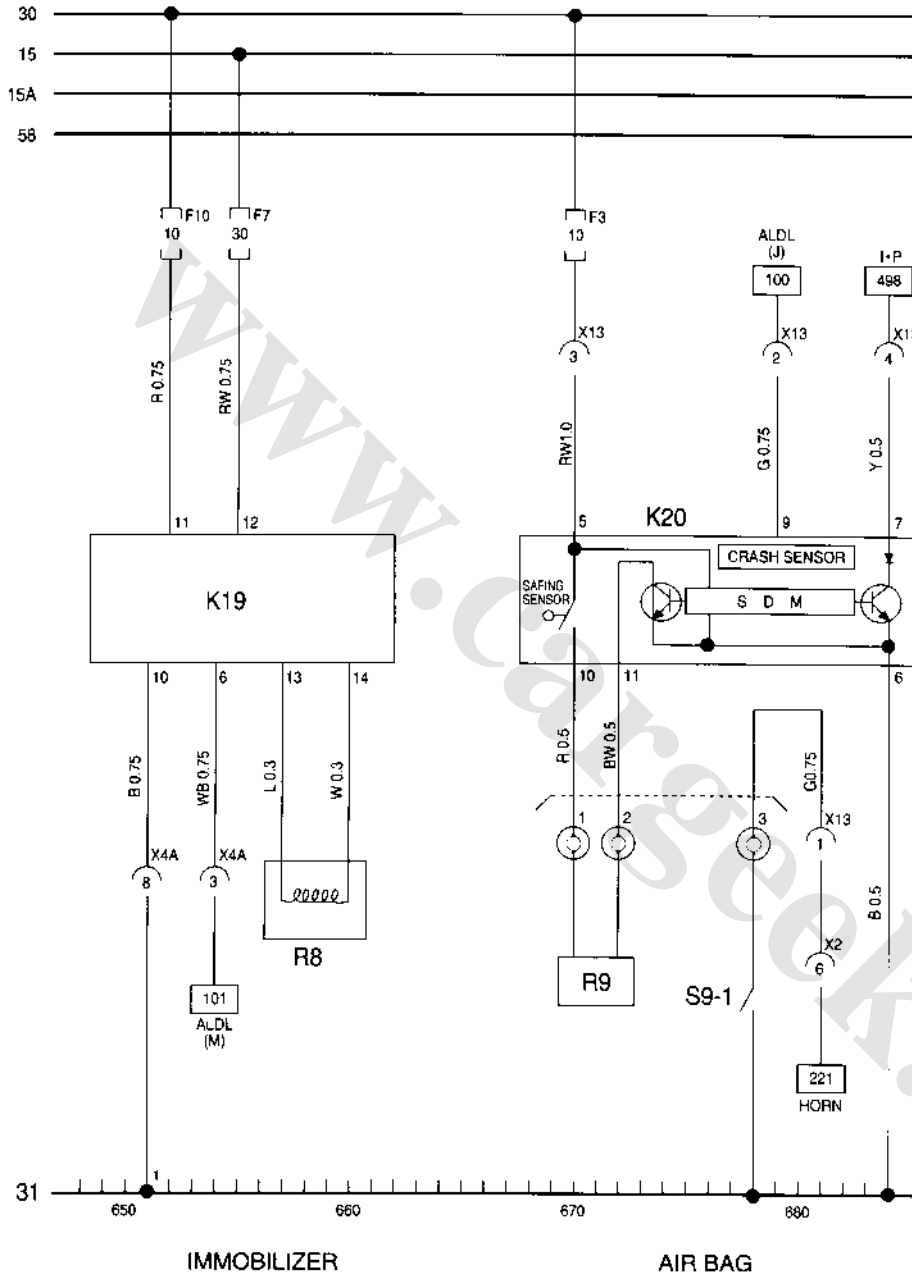

26) AIR-CONDITIONING WIRING, ELECTRIC FAN, BLOWER MOTOR WIRING(IEFI-6 TYPE)

- E48 ILLUMINATION LAMP - A/C CONTROL SWITCH
- K21 ELECTRIC FAN RELAY - HIGH SPEED
- K22 ELECTRIC FAN RELAY - LOW SPEED
- K23 A/C COMPRESSURE RELAY
- K24 BLOWER MOTOR RELAY
- M25 ELECTRIC MOTOR - AUX

- M26 ELECTRIC MOTOR
- M27 BLOWER MOTOR
- R10 BLOWER MOTOR RESISTER
- R11 ELECTRIC FAN LOW SPEED RESISTER
- S32 FAN CYCLING SWITCH
- S33 RADIATOR TEMPERATURE SWITCH

- S34 LOW PRESSURE CUT OFF SWITCH
- S35 HIGH PRESSURE CUT OFF SWITCH
- S36 A/C CONTROL SWITCH
- V1 DIODE
- Y1 A/C COMPRESSOR
- Y10 FRESH AIR

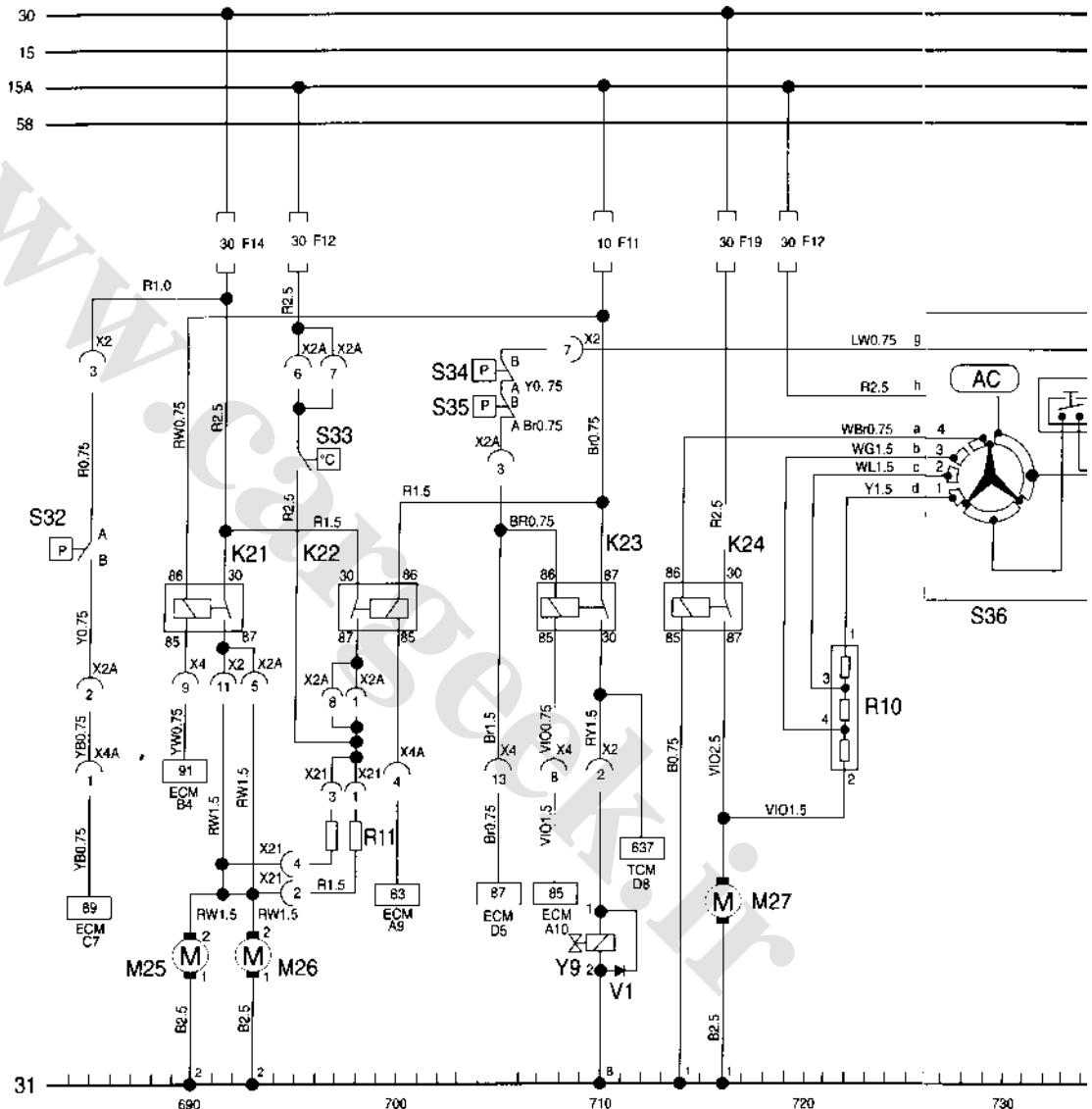

A/C (IEFI-6 TYPE)

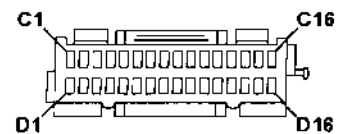
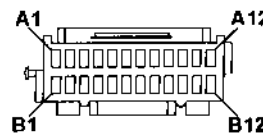
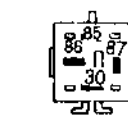
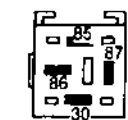
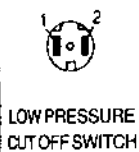

TYPE)

- S34 LOW PRESSURE CUT-OFF SWITCH
 - S35 HIGH PRESSURE CUT-OFF SWITCH
 - S36 A/C CONTROL SWITCH
- SISTER
- V1 DIODE
 - Y1 A/C COMPRESSURE
- TCH
- Y10 FRESH AIR CONTROL MODE SOLENOID

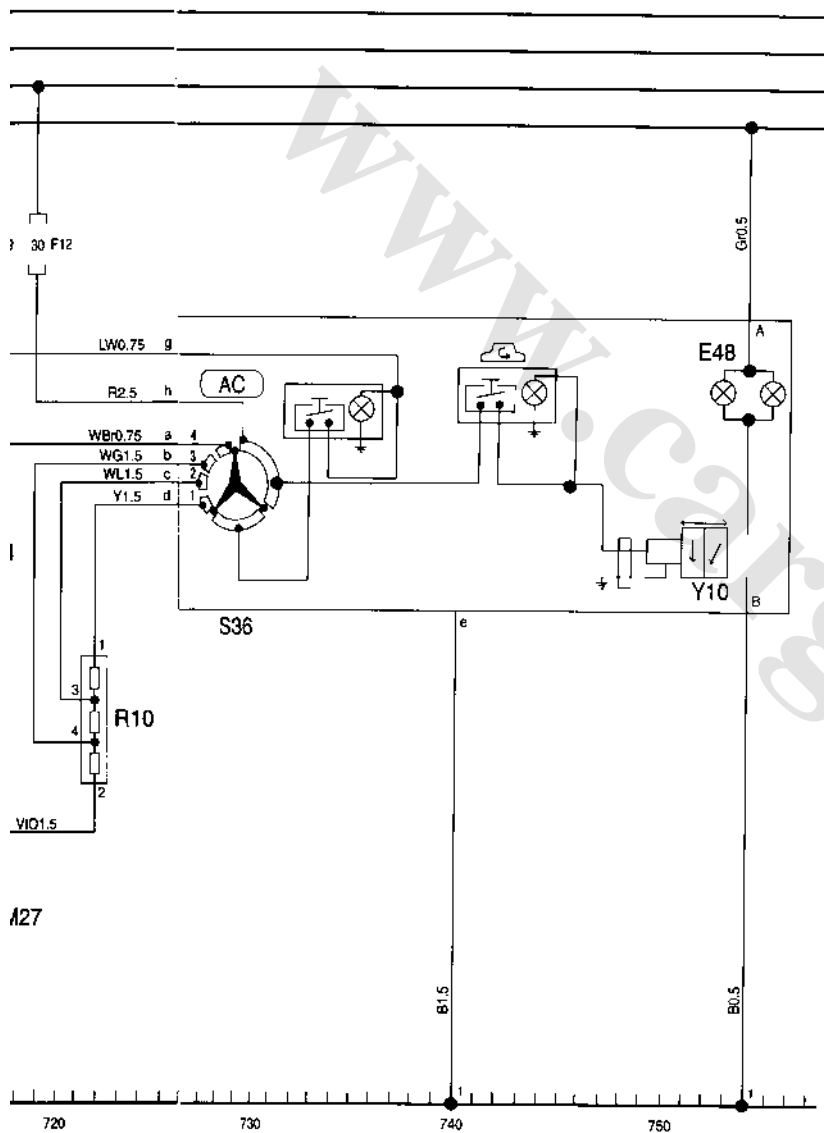

- S34 Low Pressure Shield Switch
This is installed on the air-con low pressure line and the switch is "OFF" in case that the pressure is below $1.6 \pm 0.5 \text{ kg/cm}^2$.
- S35 High Pressure Shield Switch
This is installed at the rear side of an air-con compressor (on the high pressure line) and the switch is "OFF" in case that the pressure is over 29 kg/cm^2 .
- V1 Diode
This prohibit the instant re-operation from reverse power when an air-con compressor is "OFF".
- 87 ECM Ter B8
When an air-con rotary switch is operated. ECM detects an air-con operating signal.
- 85 ECM Ter A4
When an air-con operating signal is detected from Terminal A4 and an air-con is not over load, the terminal A4 of ECM is connected to ground so that K23 air-con compressor relay is operated.
- 89 ECM Ter C9
The fan cycling switch (violet) is installed on the high pressure line at the rear side of an air-con compressor and the switch is "ON" when the pressure is over $18-21 \text{ kg/cm}^2$. At this time, the terminal C9 of ECM detects the fan cycling switch operating signal.
When ECM receive the operating signal of the fan cycling switch, under the control of ECM the terminal B4 of ECM is connected to ground so that the K21 electric fan high speed relay is operated.
- * Notice
An electric fan high speed relay operate under the condition as below:
 - 1) Coolant temperature is over 106°C .
 - 2) When the operating signal of the fan cycling switch is detected by ECM.
 - 3) When the fault code 14 of the temperature sensor is input.
 - 4) When the terminal A and B of ALDL connector is jumpered.
- S33 Temperature Switch
When the coolant temperature is over 90°C , this switch is operated so that the cooling fan is operated when the temperature is 85°C , the switch is disconnected and the cooling fan is off.

FI-6 TYPE)

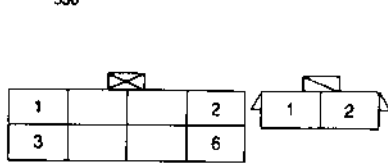
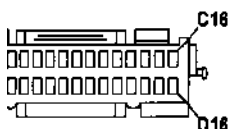

AIRCON CONTROL SWITCH

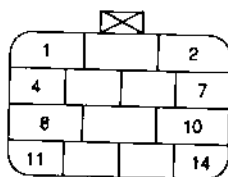

X2 CONNECTOR

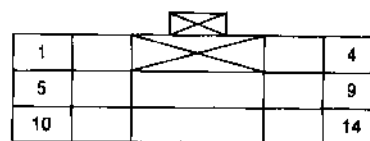

X4 CONNECTOR

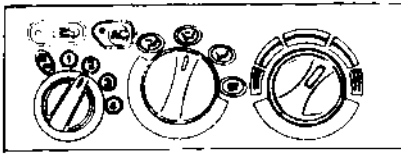

A/C SWITCH

Pressing air conditioning switch A/C once makes air conditioning system ON and lightens the indication lamp. Pressing the switch twice makes A/C system OFF and turn off the lamp.

TEMPERATURE SWITCH

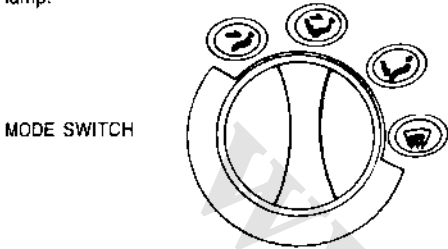
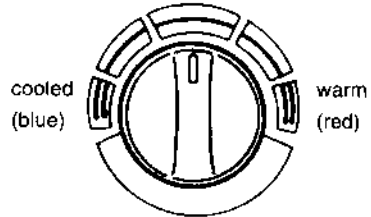

MODE SWITCH

FAN SWITCH

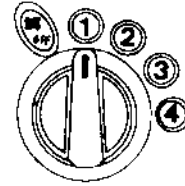

The fan switch provides speed control of the blower fan(4 fan speeds).



Air flow can be directed towards the center and sides of the vehicle.



Air flow can be directed towards the floor area of the front seat, center, and side window.



Air flow can be directed towards the floor area of the front seat.



Defrosting of front and side windows can be possible.

FRESH AIR CONTROL LEVER



↑ Circulate the air inside the vehicle.

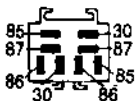
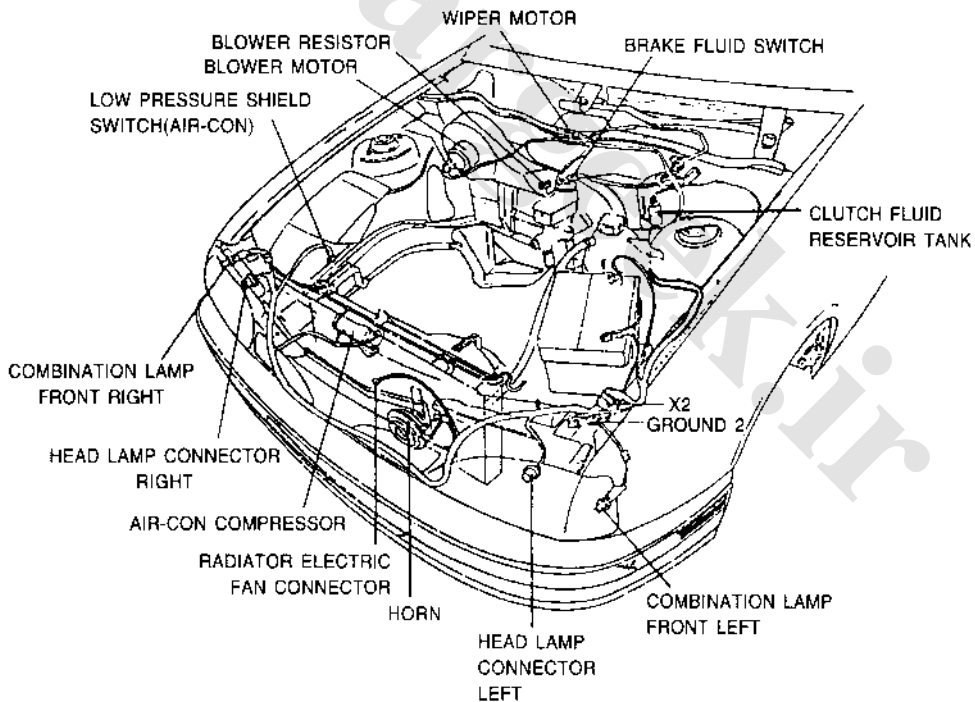

AIRCON COMPRESSOR, ELECTRIC FAN RELAY LOW SPEED (MICRO RELAY)



ELECTRIC RELAY HIGH SPEED



BLOWER SWITCH

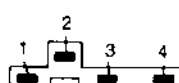

BLOWER RESISTOR



FAN CYCLING SWITCH



ELECTRIC FAN

26-1) AIR-CONDITIONING WIRING, ELECTRIC FAN, BLOWER MOTOR WIRING(IEFI-S TYPE)

E48 ILLUMINATION LAMP - A/C CONTROL SWITCH
 K21 ELECTRIC FAN RELAY - HIGH SPEED
 K22 ELECTRIC FAN RELAY - LOW SPEED
 K23 A/C COMPRESSURE RELAY
 K24 BLOWER MOTOR RELAY
 M25 ELECTRIC MOTOR - AUX

M26 ELECTRIC MOTOR
 M27 BLOWER MOTOR
 R10 BLOWER MOTOR RESISTER
 R11 ELECTRIC FAN LOW SPEED RESISTER
 S32 FAN CYCLING SWITCH
 S33 RADIATOR TEMPERATURE SWITCH

S34 LOW PRI
 S35 HIGH PR
 S36 A/C CON
 V1 DIODE
 Y1 A/C COM
 Y10 FRESH A

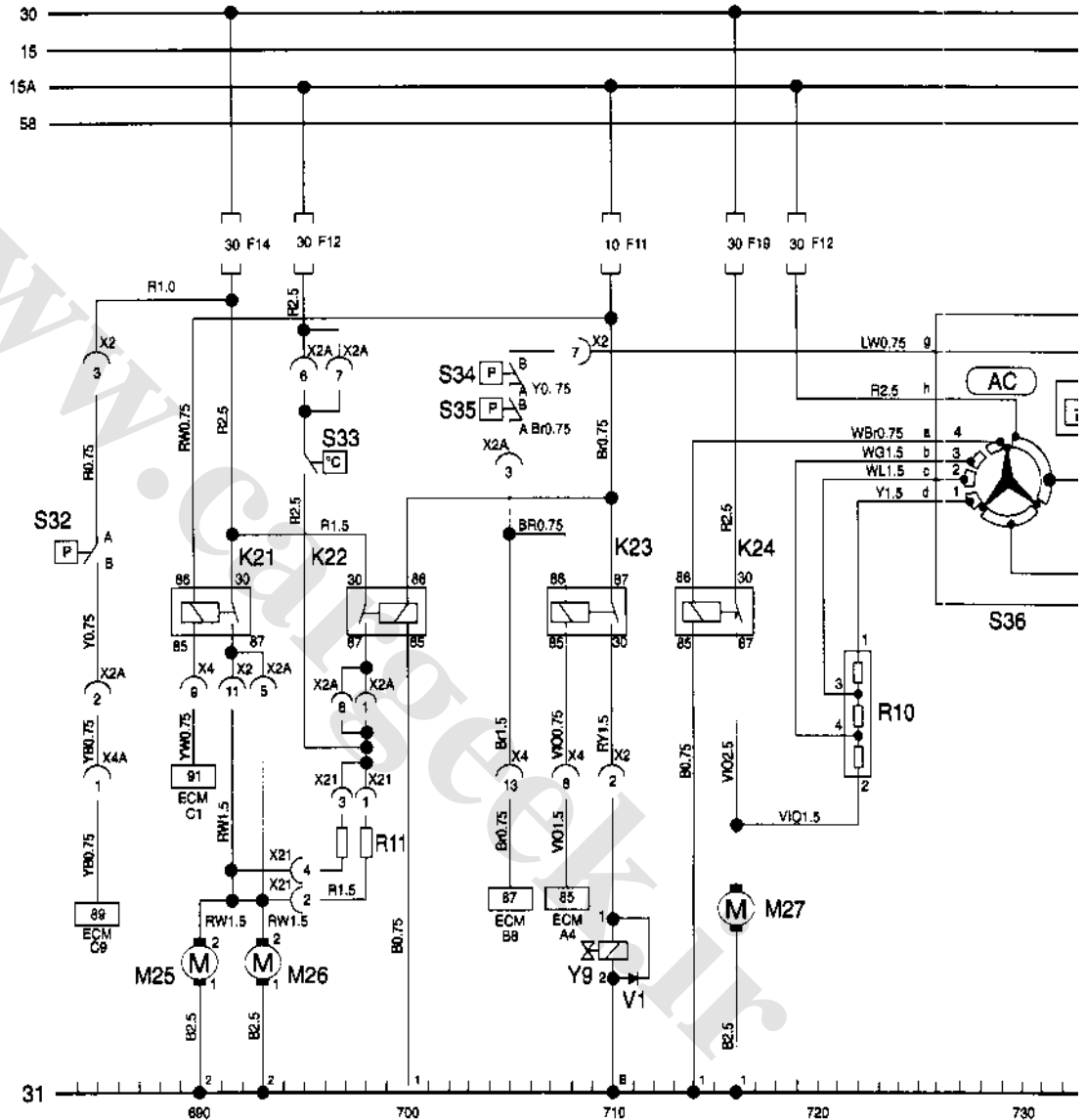

A/C (IEFI-S TYPE)

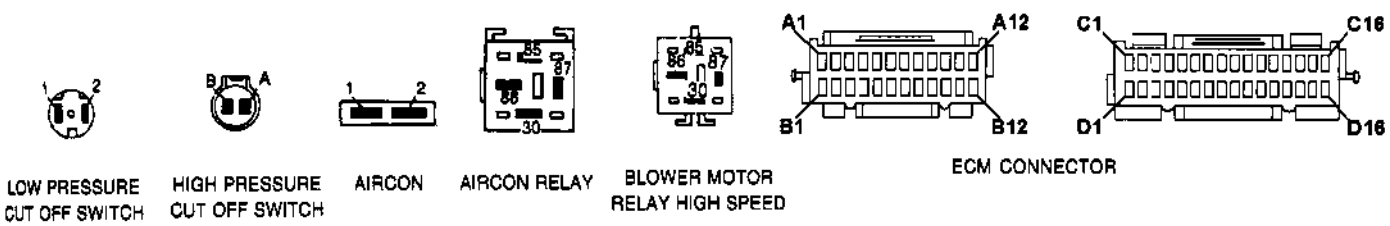

i TYPE)

- S34 LOW PRESSURE CUT-OFF SWITCH
- S35 HIGH PRESSURE CUT-OFF SWITCH
- S36 A/C CONTROL SWITCH
- ISTER V1 DIODE
- CH Y1 A/C COMPRESSURE
- Y10 FRESH AIR CONTROL MODE SOLENOID

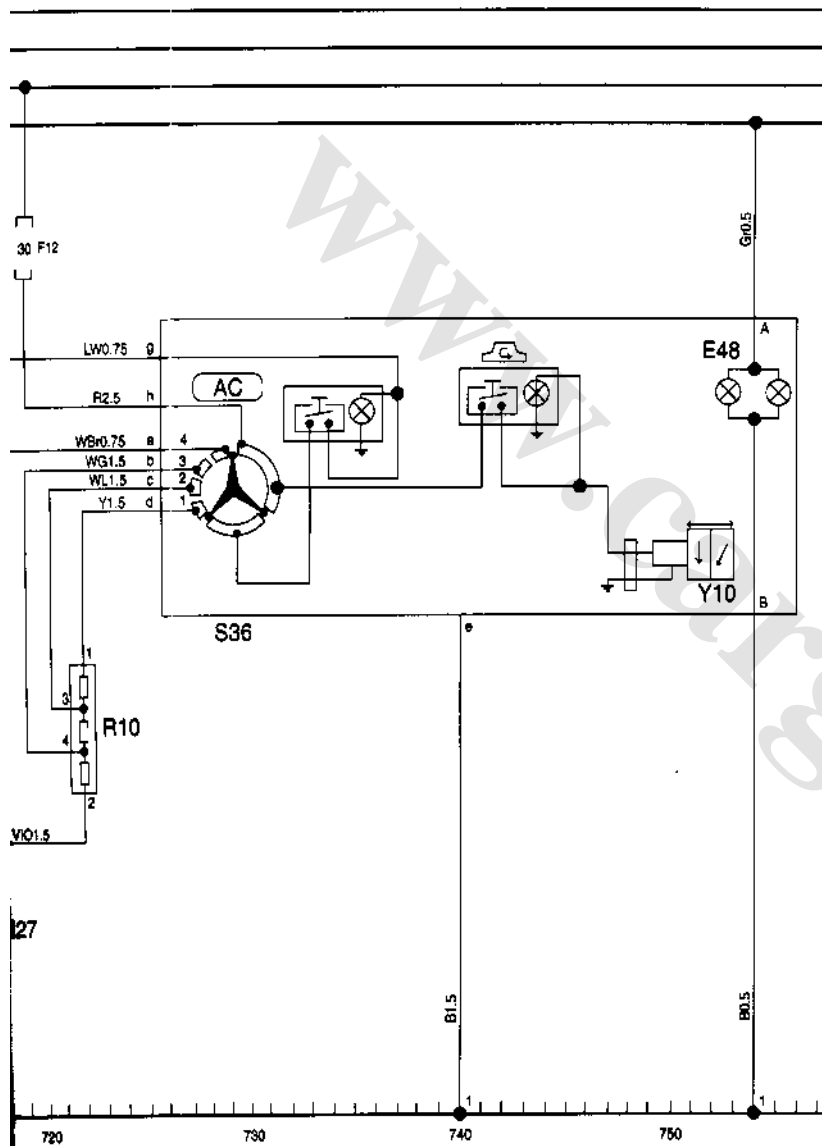

- S34 Low Pressure Shield Switch
This is installed on the air-con low pressure line and the switch is "OFF" in case that the pressure is below $1.6 \pm 0.5 \text{ kg/cm}^2$.
- S35 High Pressure Shield Switch
This is installed at the rear side of an air-con compressor (on the high pressure line) and the switch is "OFF" in case that the pressure is over 29 kg/cm^2 .
- V1 Diode
This prohibits the instant re-operation from reverse power when an air-con compressor is "OFF".
- 87 ECM Ter B8
When an air-con rotary switch is operated. ECM detects an air-con operating signal.
- 85 ECM Ter A4
When an air-con operating signal is detected from Terminal A4 and an air-con is not over load, the terminal A4 of ECM is connected to ground so that K23 air-con compressor relay is operated.
- 89 ECM Ter C9
The fan cycling switch (violet) is installed on the high pressure line at the rear side of an air-con compressor and the switch is "ON" when the pressure is over $18\text{-}21 \text{ kg/cm}^2$. At this time, the terminal C9 of ECM detects the fan cycling switch operating signal.
When ECM receive the operating signal of the fan cycling switch, under the control of ECM the terminal B4 of ECM is connected to ground so that the K21 electric fan high speed relay is operated.
- * Notice
An electric fan high speed relay operate under the condition as below:
 - 1) Coolant temperature is over 106°C .
 - 2) When the operating signal of the fan cycling switch is detected by ECM.
 - 3) When the fault code 14 of the temperature sensor is input.
 - 4) When the terminal A and B of ALDL connector is jumpered.
- S33 Temperature Switch
When the coolant temperature is over 90°C , this switch is operated so that the cooling fan is operated when the temperature is 85°C , the switch is disconnected and the cooling fan is off.

Pi-S TYPE)

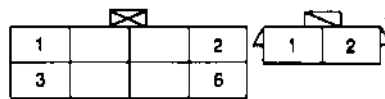
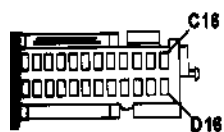

AIRCON CONTROL SWITCH

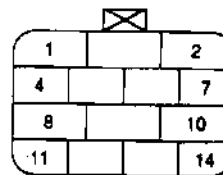

X2 CONNECTOR

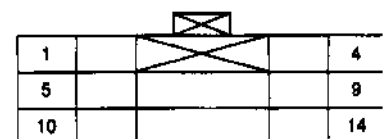

X4 CONNECTOR

27) HEAD LAMP LEVELING DEVICE(OPTION)

1. HLLD Actuating Motor

(1) Construction and working principle

Actuating motor works by electric power supplied by driver's operation of head lamp leveling device switch. Worm and worm gear change the rotating power of the actuating motor into linear movement which pushes and pulls the device shaft.

The shaft linked with the reflector, moves forward and backward.

Then the reflector of the head lamp can rotate up and down around the pivot.

The more the reflector turns downward the bigger the downward – inclination of dipped – beam, and vice versa.

So, when driver rotates the switch to downward, the reflector of the lamp turns downward around the pivot.

If the driver turns it to the opposite direction the reflector moves upward around the pivot.

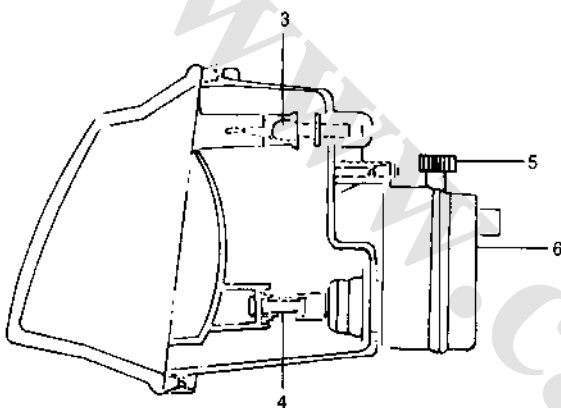

1. AIMING POINT TO LEFT AND RIGHT
2. AIMING POINT TO UP AND DOWN
3. PIVOT
4. DEVICE SHAFT
5. ADJUSTING KNOB
6. ACTUATING MOTOR

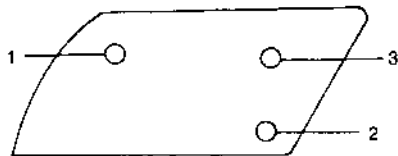

(2) HLLD switch

- Position 0
One person on driver's seat .
Two persons on front seat.
(One driver and one co-driver)
- Position 1
All seats occupied
(5 persons in passenger compartment)
- Position 2
5 persons in passenger compartment plus weight(Max 160 kg) in load-
ing compartment.
- Position 3
One person on driver's seat plus weight(Max 350 kg) in loading com-
partment.

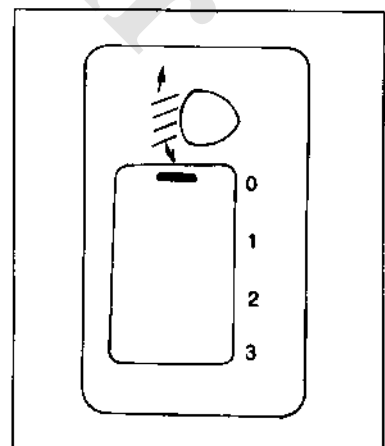

2. Test Method

- R2 HLLD CONTROL SWITCH
- M4 HLLD MOTOR (LEFT)
- M5 HLLD MOTOR (RIGHT)

- 1) With ignition switch "ON", disconnect the HLLD switch connector.
- 2) Connect voltage meter between the HLLD switch connector, terminal "2" and the vehicle body ground, and measure the voltage.

Normal : 12V

If the voltage is abnormal, check the open of the wiring and fuse No. 6.

- 3) Measure the resistance between the HLLD switch terminal "4" and "2".

If the resistance is abnormal, exchange the HLLD switch.

Position 0	0.2ohm
Position 1	156.6ohms
Position 2	234ohms
Position 3	252ohms

